

# CdTe and CdZnTe Array Detectors

For Space Experiment

Tadayuki Takahashi

Institute of Space and Astronautical Science (ISAS)

JAXA

Suzaku July.10th 2005

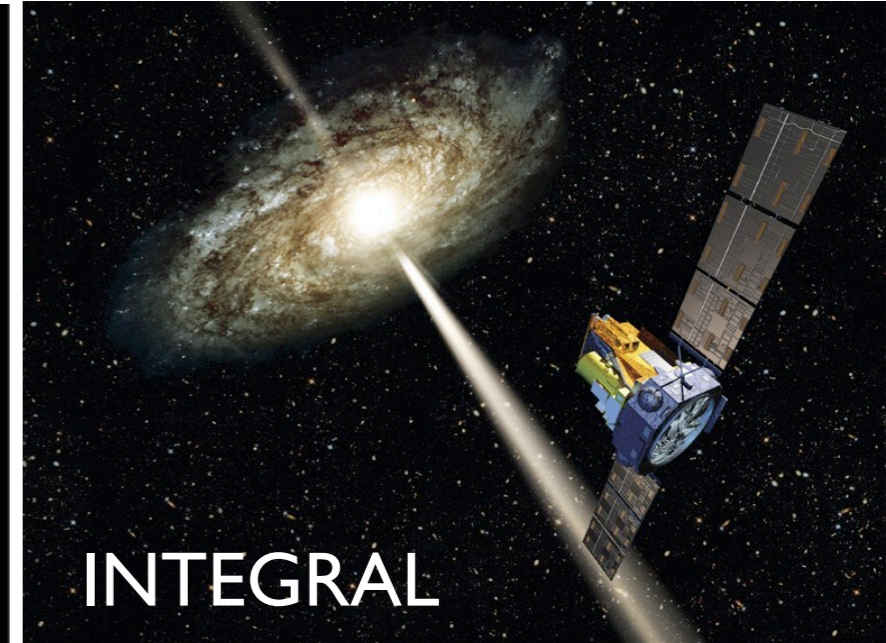
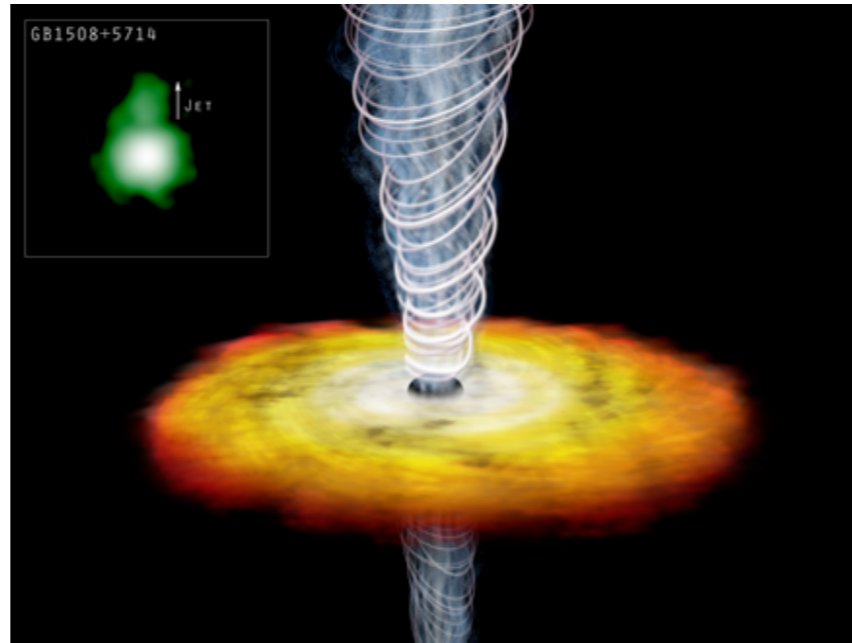

# CdTe & CdZnTe

- High Z semiconductor  
( $Z_{\text{Cd}} = 48, Z_{\text{Te}} = 52$ ),  $\rho = 5.9 \text{ g/cm}^3$

semi-conductor	density [g/cm <sup>3</sup> ]	Z	$E_{\text{gap}}$ [eV]	$\epsilon$ [eV]	$X_0$ [cm]
Si	2.33	14	1.12	3.6	9.37
Ge	5.33	32	0.67	2.9	2.30
CdTe	5.85	48,52	1.44	4.43	1.52
CdZnTe	5.81		1.6	4.6	
HgI <sub>2</sub>	6.40	80,53	2.13	4.2	1.16
GaAs	5.32	31, 33	1.42	4.3	2.29

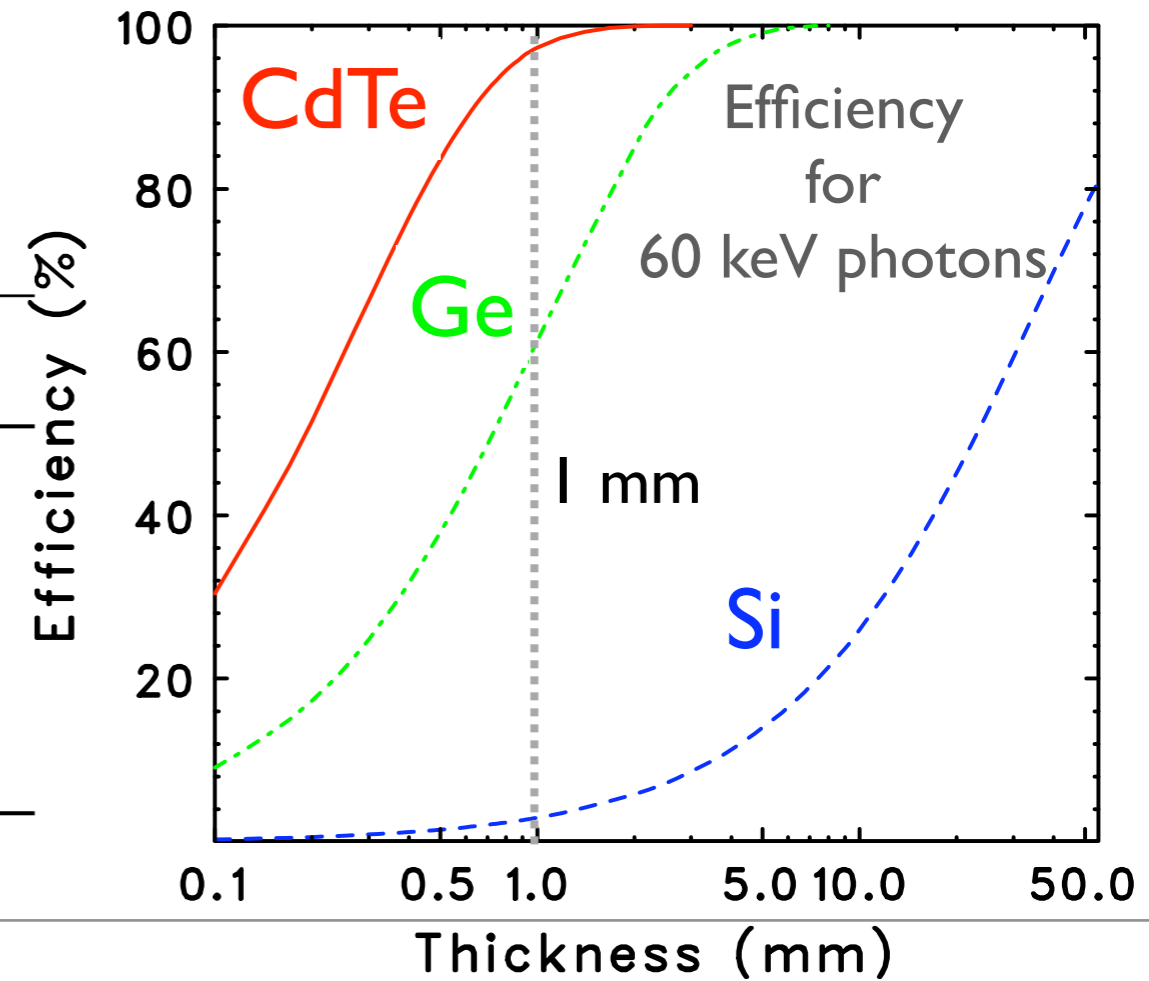

- Wide band gap ( $E_g: 1.5 \text{ eV}, \epsilon: 4.4 \text{ eV}$ )  
⇒ Allows room temperature operation or the operation under moderate cooling ( $> -20 \text{ }^\circ\text{C}$ )
- High resistivity  $\sim 10^9 \text{ } \Omega\text{cm}$  for CdTe  $\sim 10^{10-11} \text{ } \Omega\text{cm}$  for HPB-CdZnTe
  - With “ohmic” contacts, the detector can be operated as a simple “solid ionization chamber”. In principle, it has no polarity
  - 10ns timing resolution possible



# Recent Achievements of Crystal Growth



← HPB-CdZnTe  
(eV Products)

THM-CdTe →  
(ACRORAD)

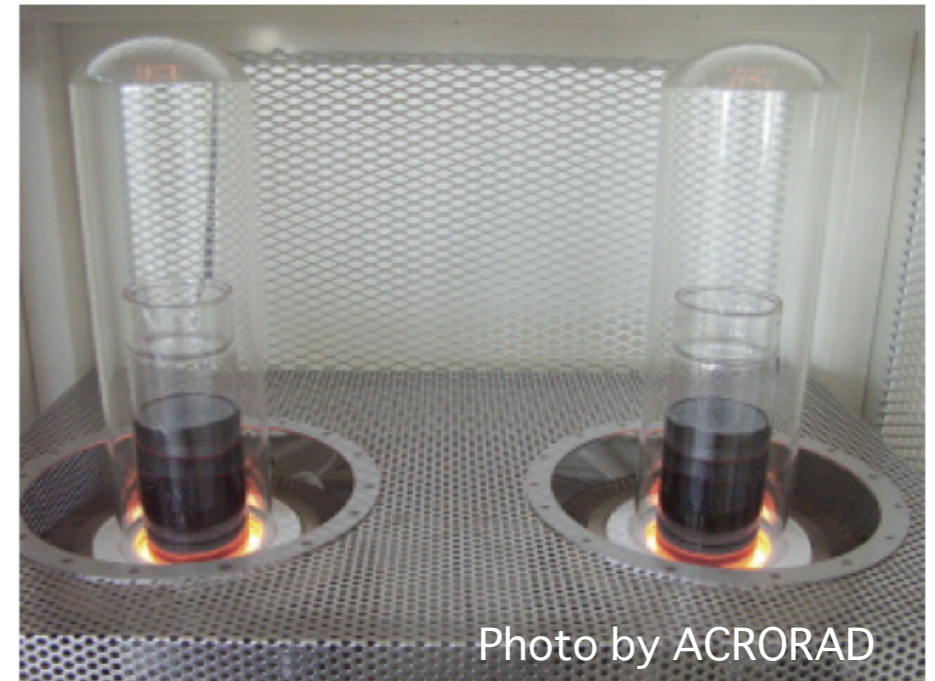

High-Pressure Bridgman (HPB)

CdTe single crystal  
Travel Heater Method (THM)

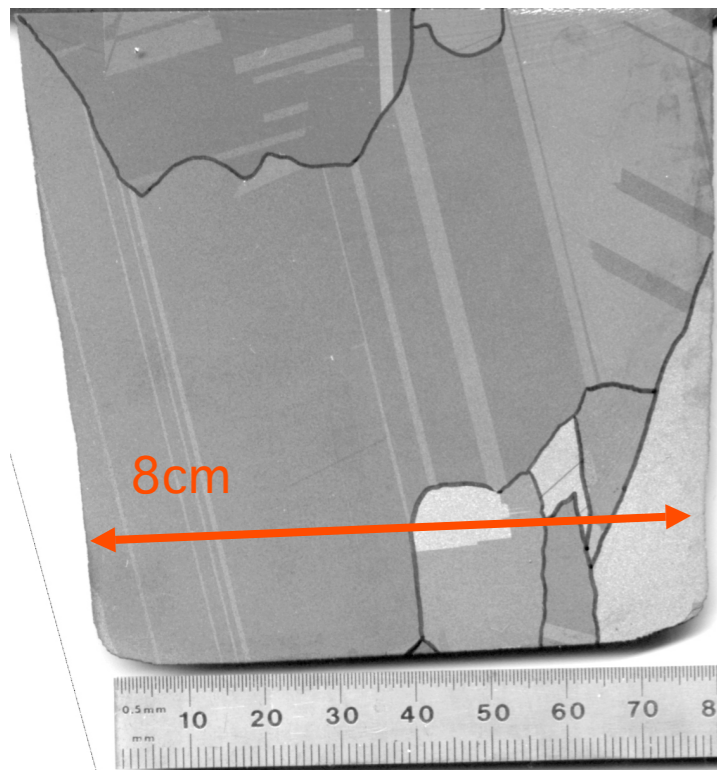

← Large Volume  
(as poly crystal)  
High Resistivity

Large Wafer  
of single crystal →  
High Uniformity

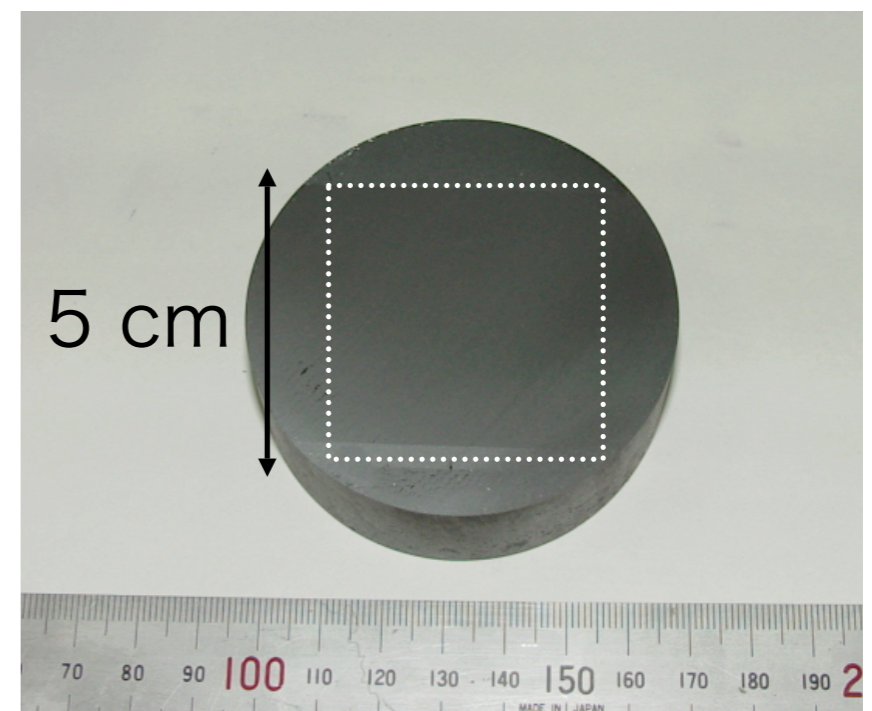



# Large Scale CdTe/CZT Experiment in Space (I)

## INTEGRAL IBIS (Launched in 2004)

First large (60x60 cm) CdTe gamma camera  
(16384 planar CdTe THM detectors 4x4x2 mm)

Field of view : 19° FWHM  
Angular resolution : 12'  
Energy range : 15 keV- 250 keV  
Energy resolution : 9 % (60 keV)  
Time resolution : 100 microsec

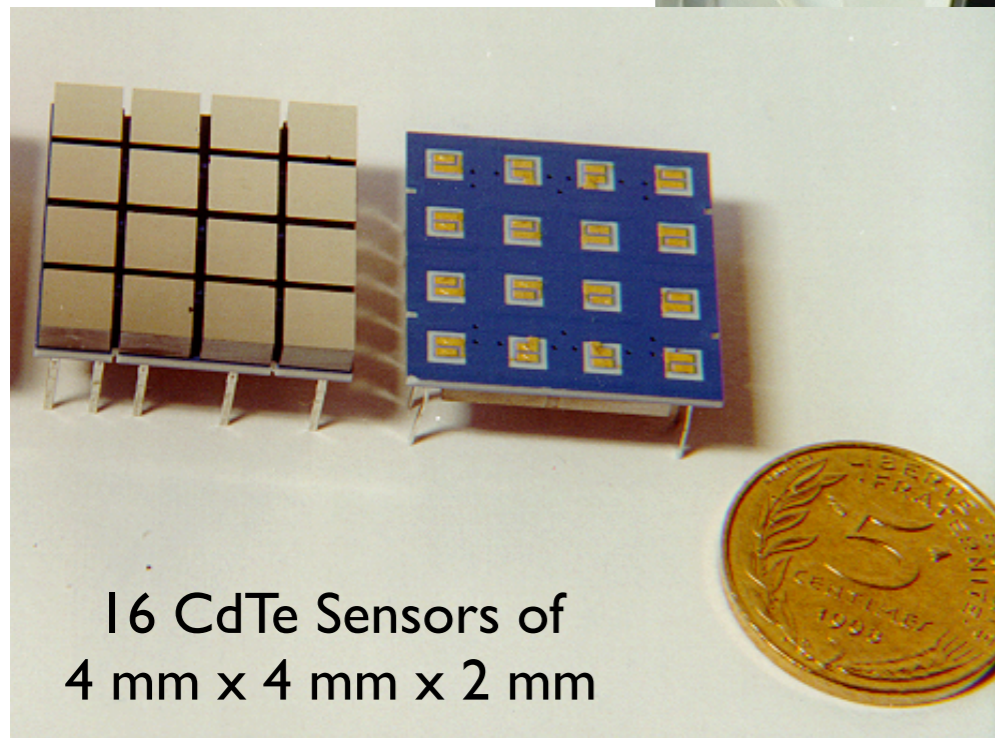
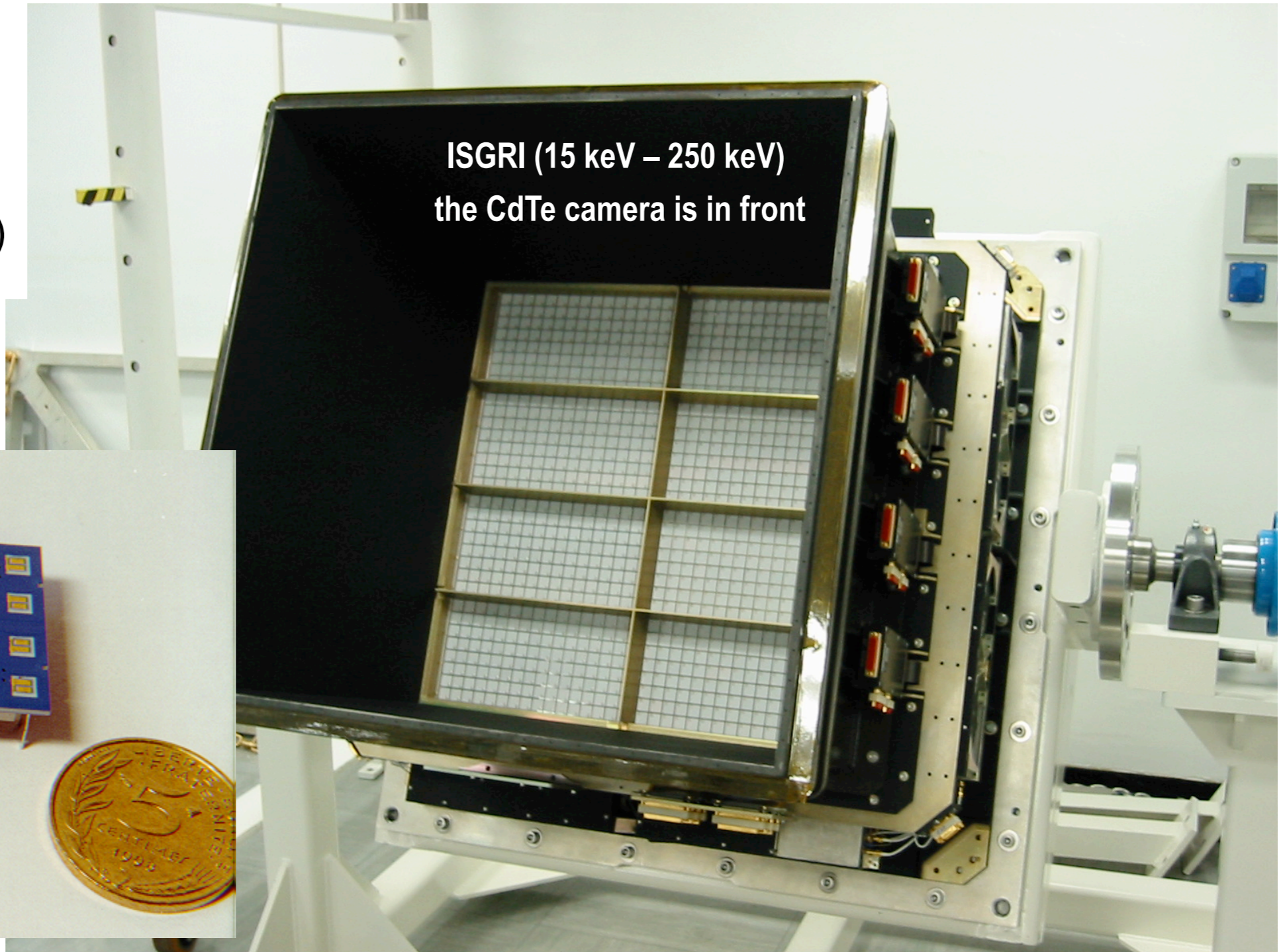

16 CdTe Sensors of  
4 mm x 4 mm x 2 mm



# Large Scale CdTe/CZT Experiment in Space (2)

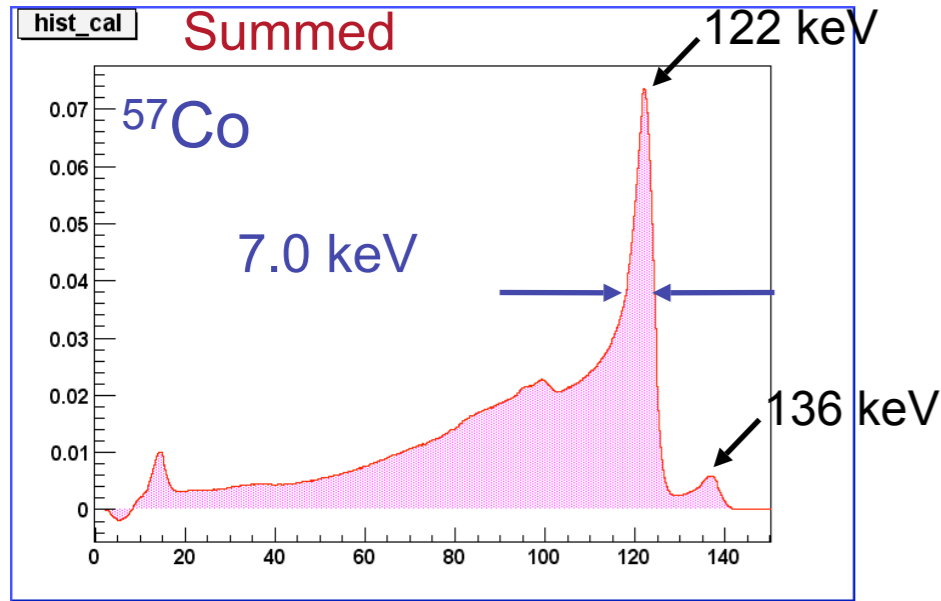

Burst Alert Telescope (BAT) on Swift  
(Launched in 2004)

## XA Chip (IDEAS)

### 32,768 CZT

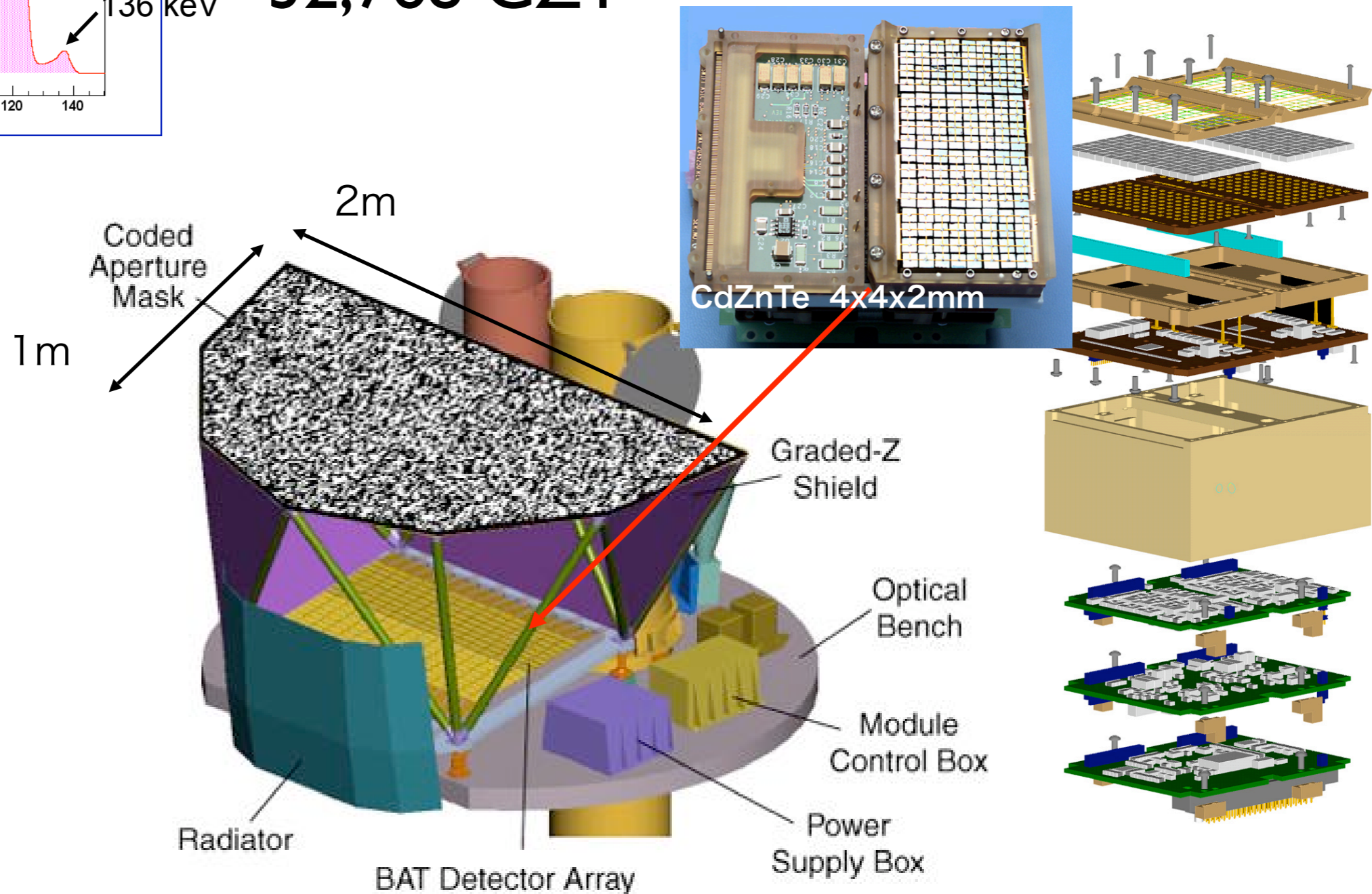



# Large Scale CdTe/CZT Experiment in Space (2)

Burst Alert Telescope (BAT) on Swift  
(Launched in 2004)

## XA Chip (IDEAS)

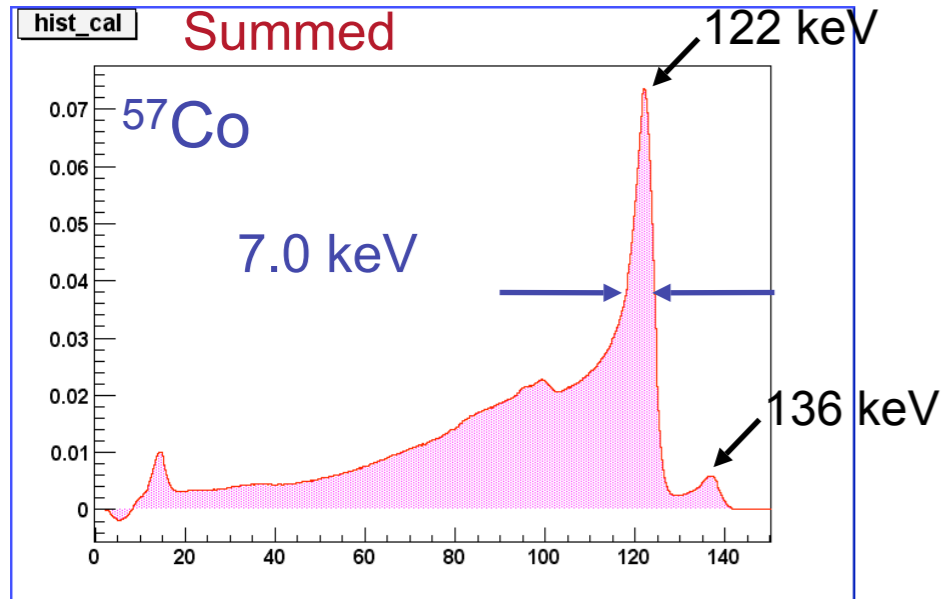

### 32,768 CZT

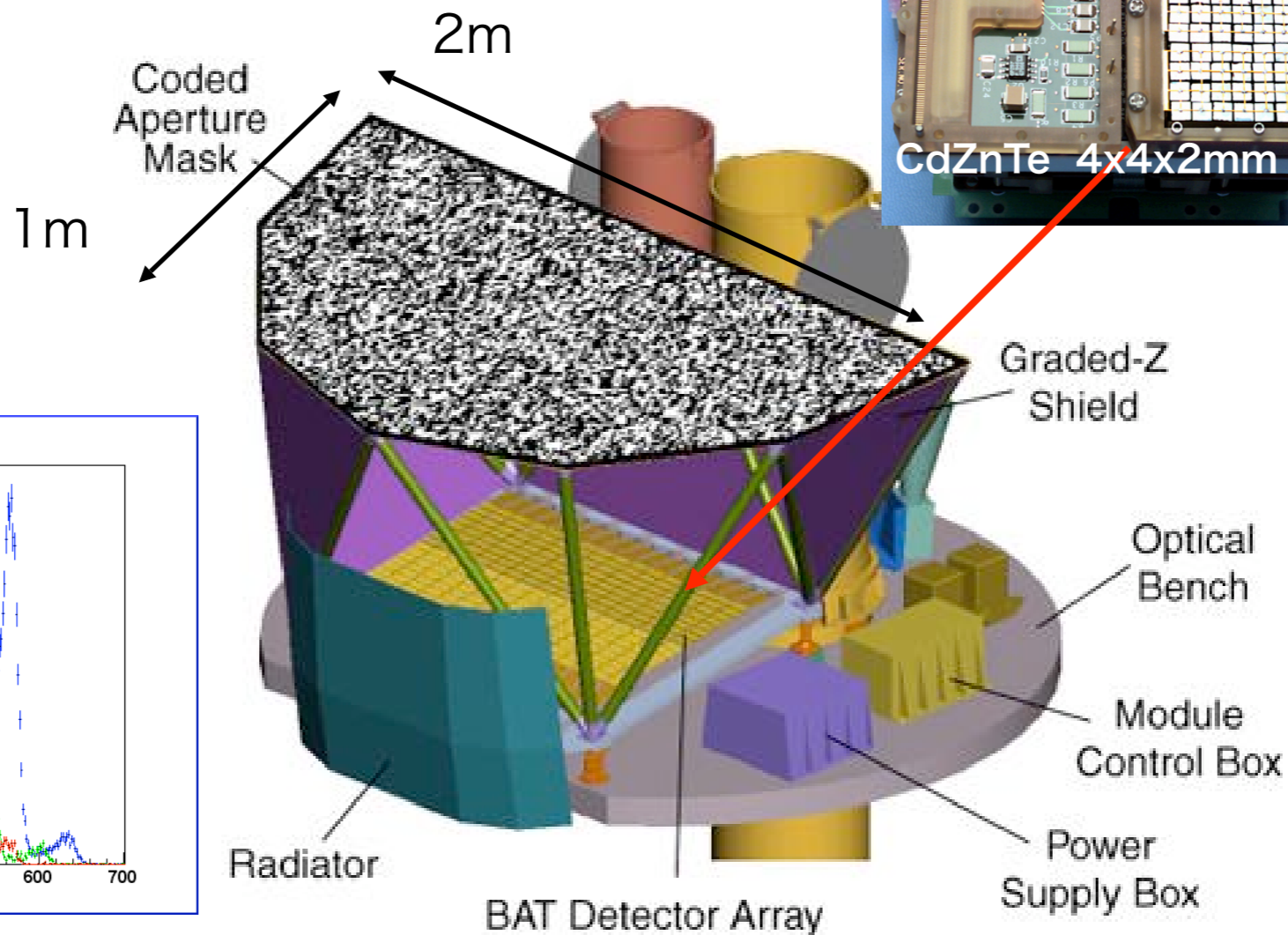
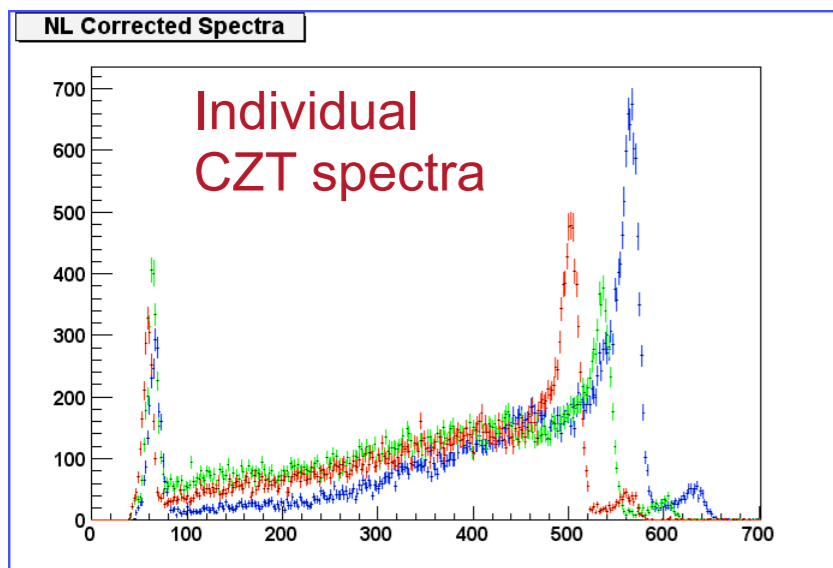
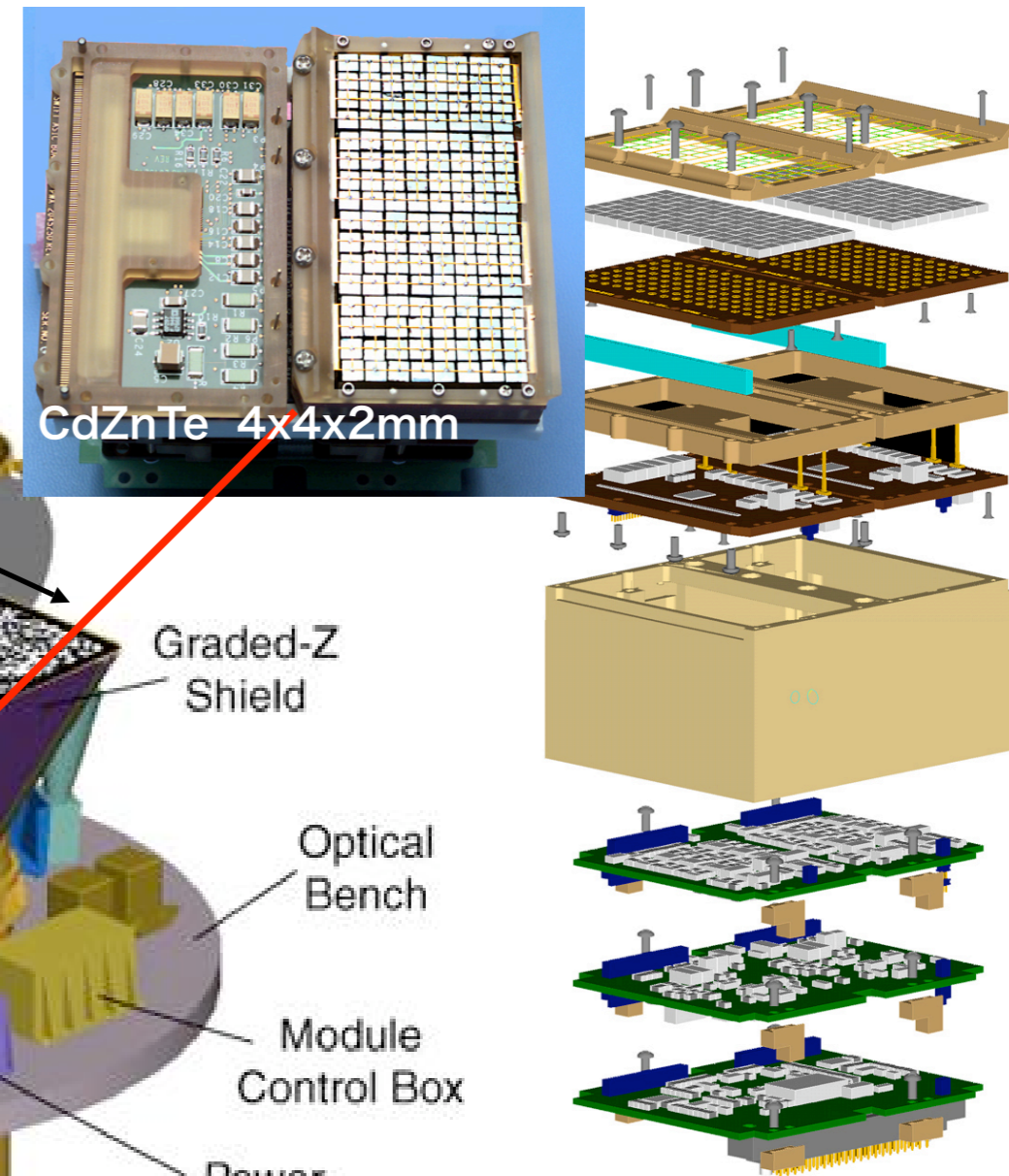



# Poor charge-carriers transport properties

$\mu\tau$  products

electron :  $3 \times 10^{-3} \text{ cm}^2/\text{V}$     $\text{Si} : 0.42$

hole

THM-CdTe :  $3 \times 10^{-4} \text{ cm}^2/\text{V}$     $\text{Si} : 0.22$

HPB-CdZnTe :  $\sim 0.5 \times 10^{-4} \text{ cm}^2/\text{V}$

**Case I** : signal is mostly due to the movement of electrons

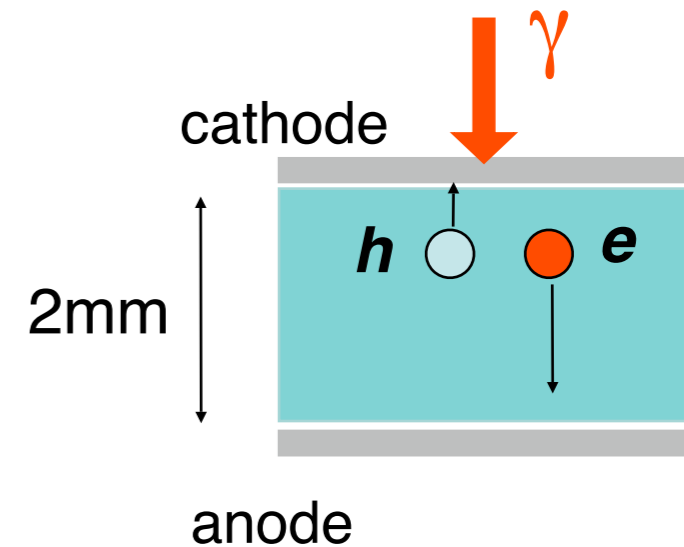

Even with the thickness of 2mm effect of charge trap is significant

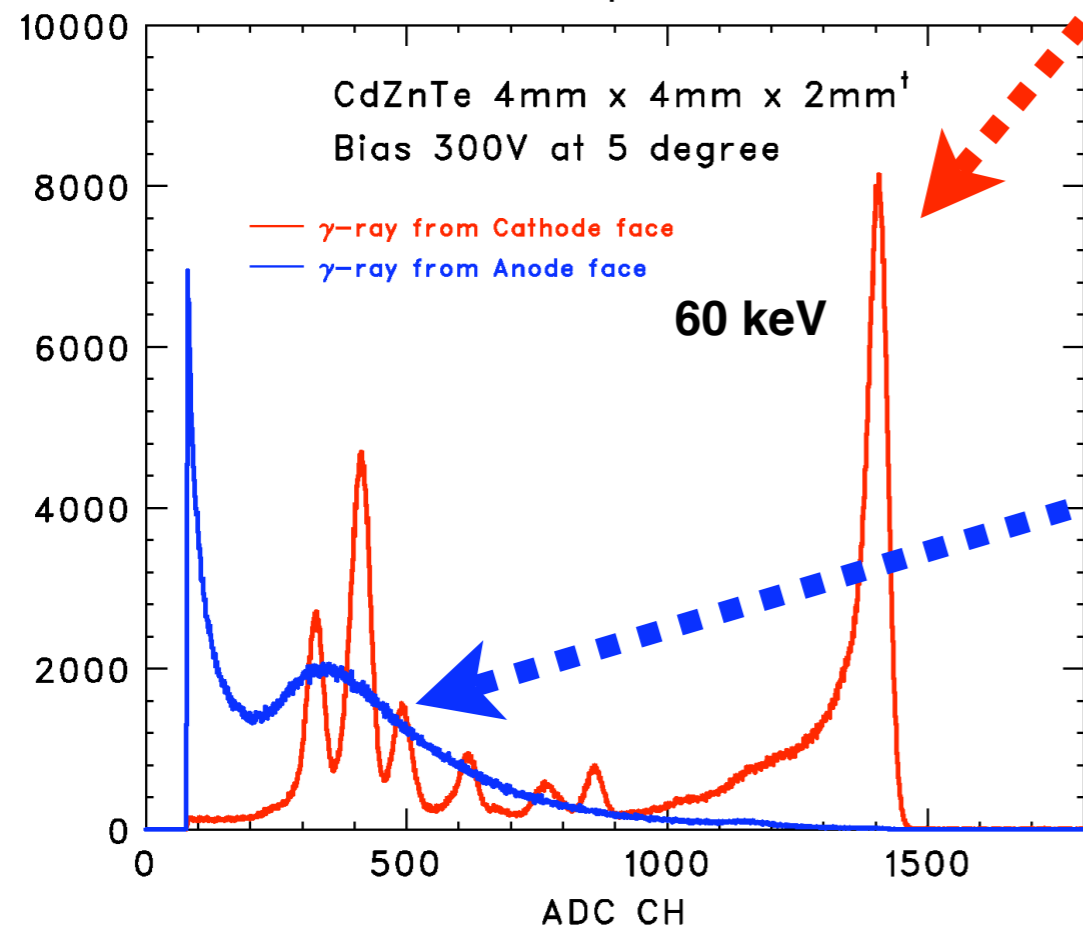

**Case II** : signal is mostly due to the movement of holes

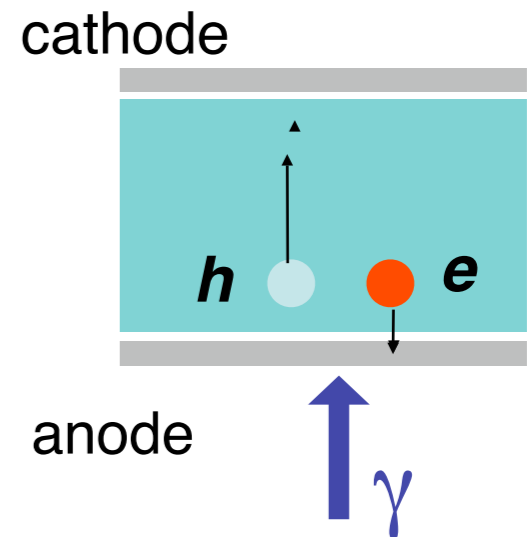



# Improvements

## High Resolution CdTe Diode

(ISAS-JAXA / ACRORAD)

1. Thin device (0.3-1.0 mm)
2. Schottky Diode (In/CdTe/Pt)
3. Guard Ring

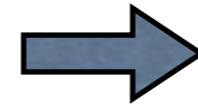

- Extremely low leakage  
10 pA for 2x2x0.5mm<sup>2</sup> at 20°C at 500 V
- High bias voltage



- Full Charge Collection (NO-TAIL)

Takahashi et al. IEEE NS 49, 1297, 2002

CdTe Diode(-40 deg.) 3 mm x 3 mm x 1.0 mm

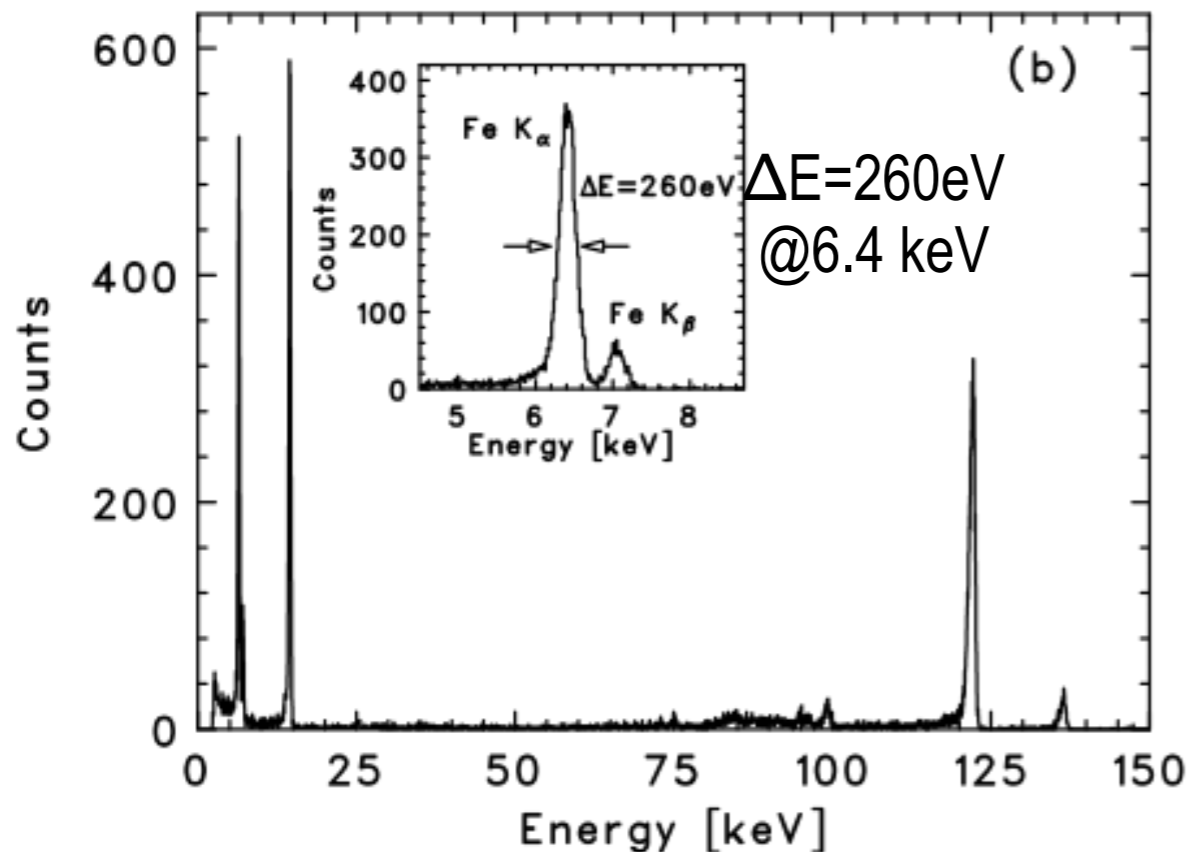

Taken with Amptek system

Takahashi et al. 2005

CdTe Diode(20 deg)

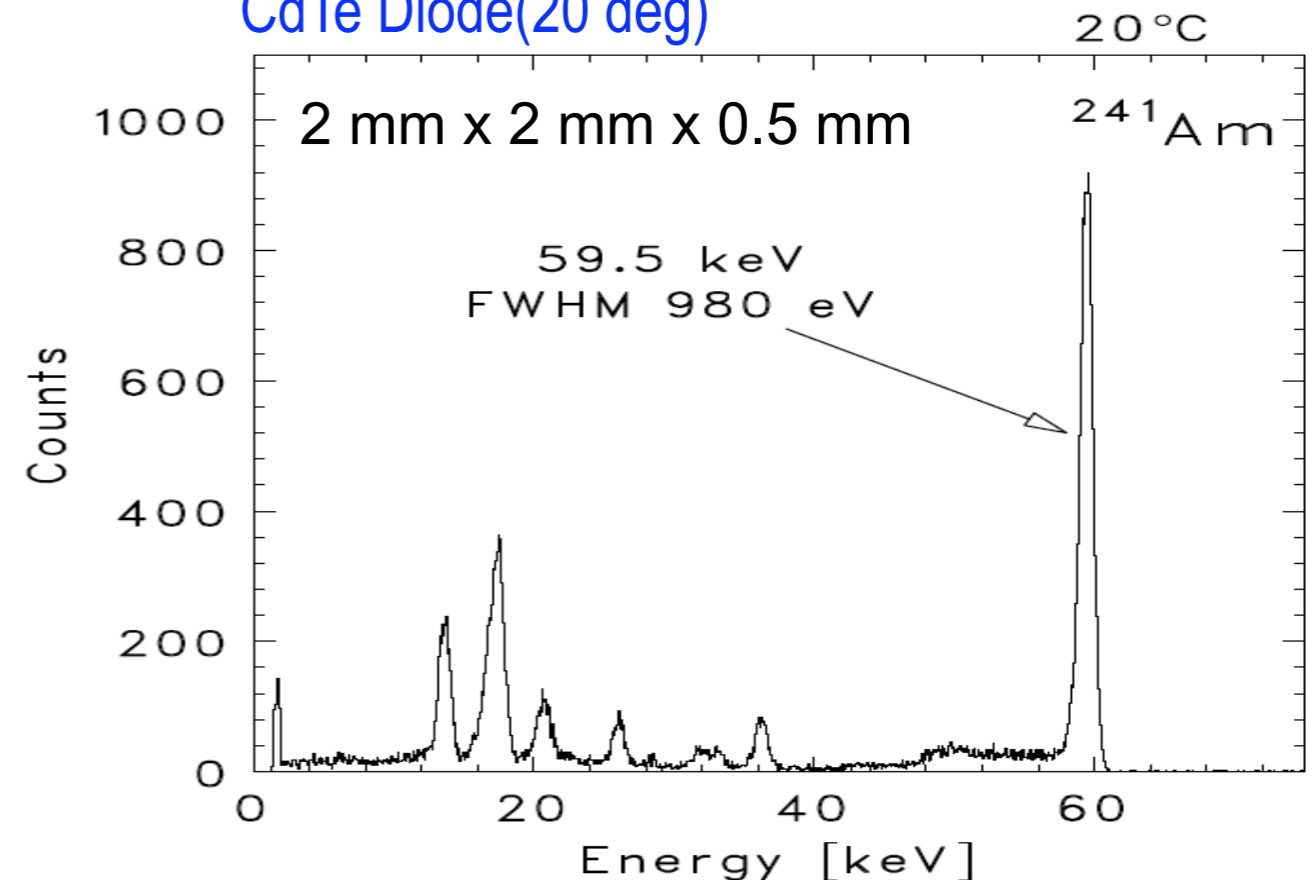

Tanaka et al. 2003

# Improvements

## High Resolution CdTe Diode

(ISAS-JAXA / ACRORAD)

1. Thin device (0.3-1.0 mm)
2. Schottky Diode (In/CdTe/Pt)
3. Guard Ring

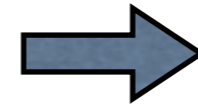

- Extremely low leakage  
10 pA for 2x2x0.5mm<sup>2</sup> at 20°C at 500 V
- High bias voltage



- Full Charge Collection (NO-TAIL)

Takahashi et al. IEEE NS 49, 1297, 2002

CdTe Diode(-40 deg.) 3 mm x 3 mm x 1.0 mm

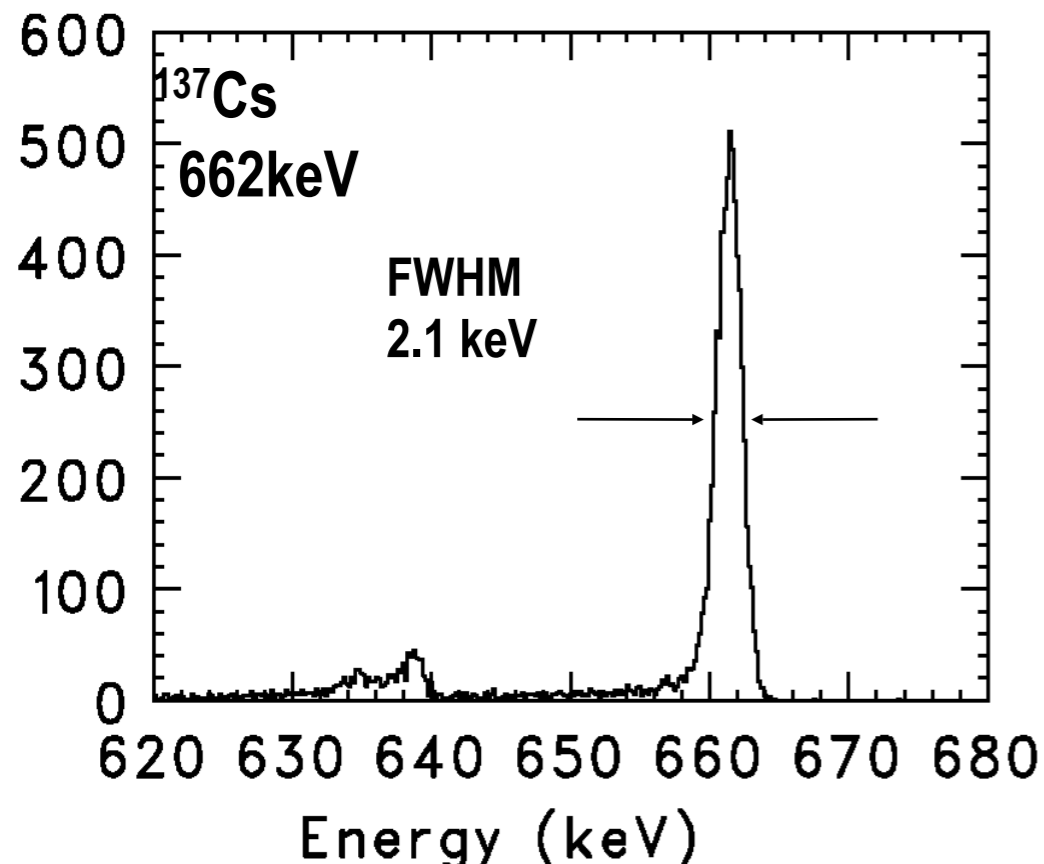

et al. 2005

CdTe Diode(20 deg)

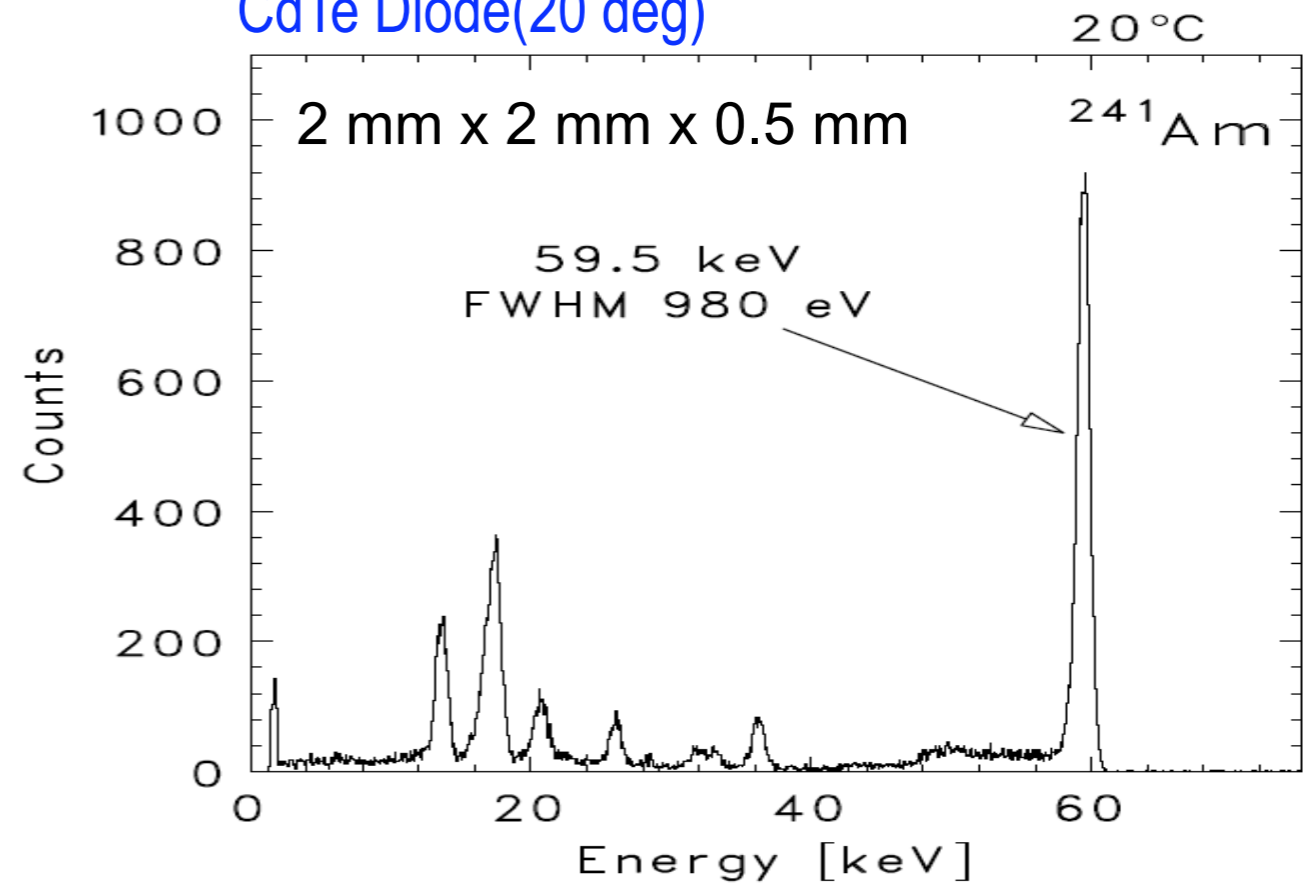

Tanaka et al. 2003



# CdTe Pixel “Gamma-ray Module”

ISAS/JAXA

8x8 module

area: 18 x 18 mm<sup>2</sup>, thickness: 0.5 mm  
pixel size: 2 x 2 mm<sup>2</sup>, 64ch, cathode side  
guard ring : 1 mm width  
backing : 200 micron thick Al<sub>2</sub>O<sub>3</sub>

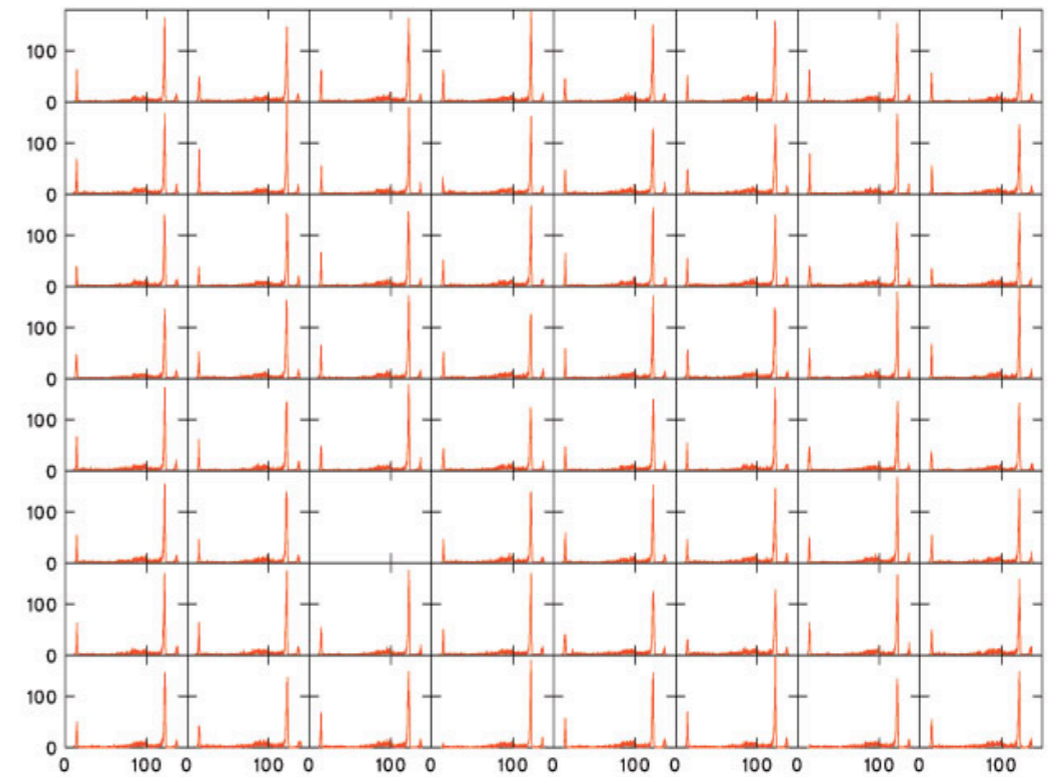
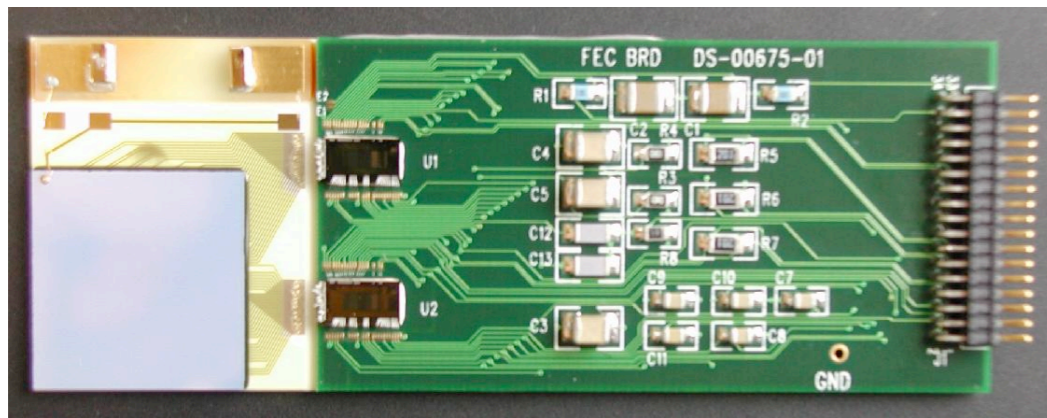

area: 11.2 x 11.2 mm<sup>2</sup>, thickness: 0.75 mm  
pixel size: 1.35 x 1.35 mm<sup>2</sup>, 64 ch

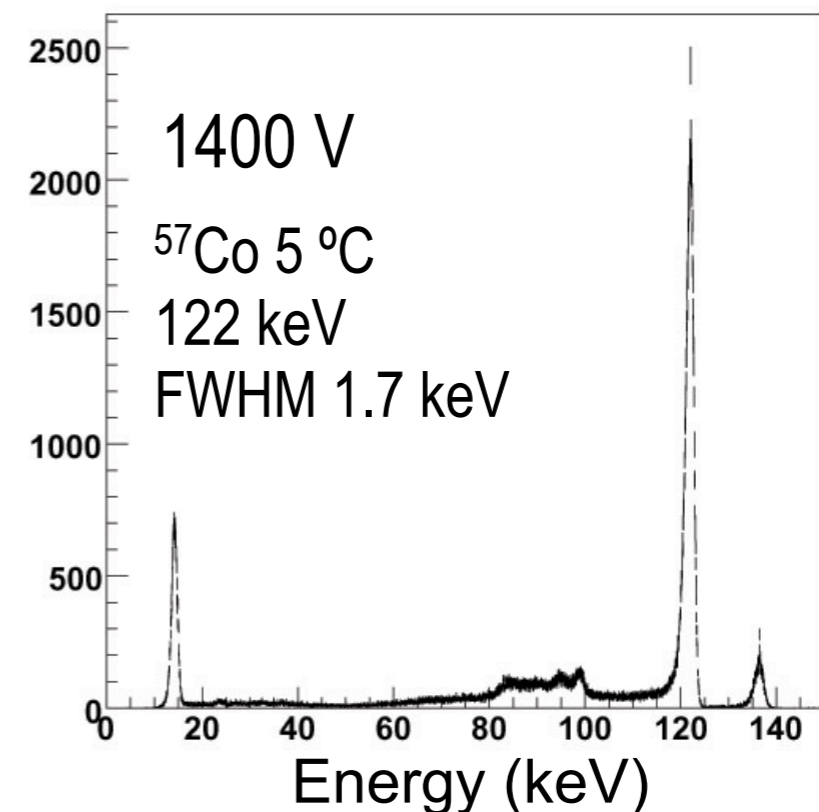
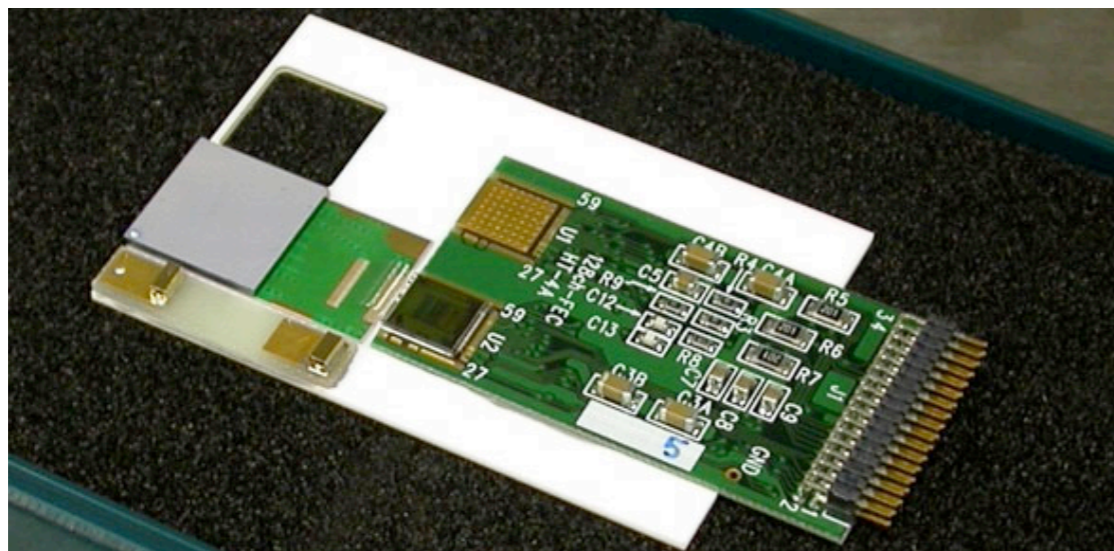

New ASIC (VA32TA/VA64TA) by ISAS/SLAC/IDEAS



# Application of Gamma-ray Module

Once we establish the module, we can expand it to...

ISAS/JAXA

- Large Area Detector

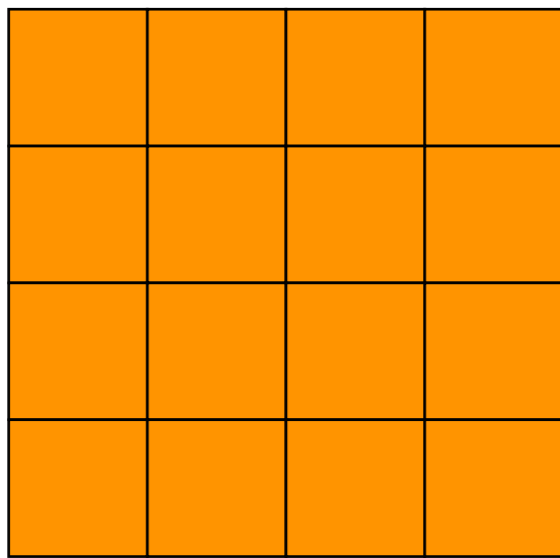

4 ~ 8 cm

- Stacked Detector



5 ~ 10 mm

Large Area 1024 pixel CdTe Array  
(pixel size 1.4 x 1.4 mm<sup>2</sup>)

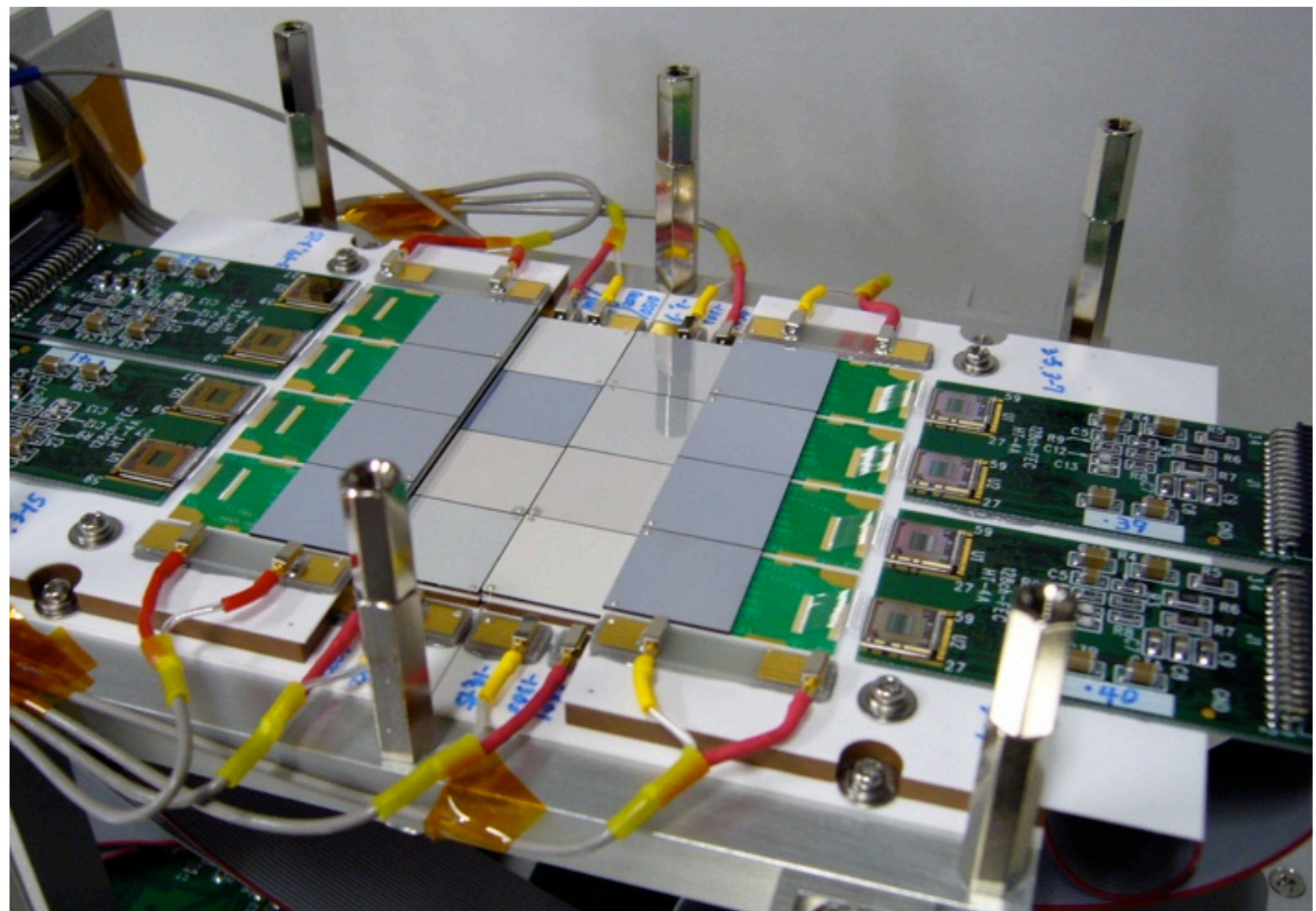



# Si/CdTe Compton Telescope

High Energy Resolution of CdTe pixel is the KEY  
for BOTH Angular Resolution and Energy Resolution

ISAS/JAXA  
w H. Tajima in  
SLAC

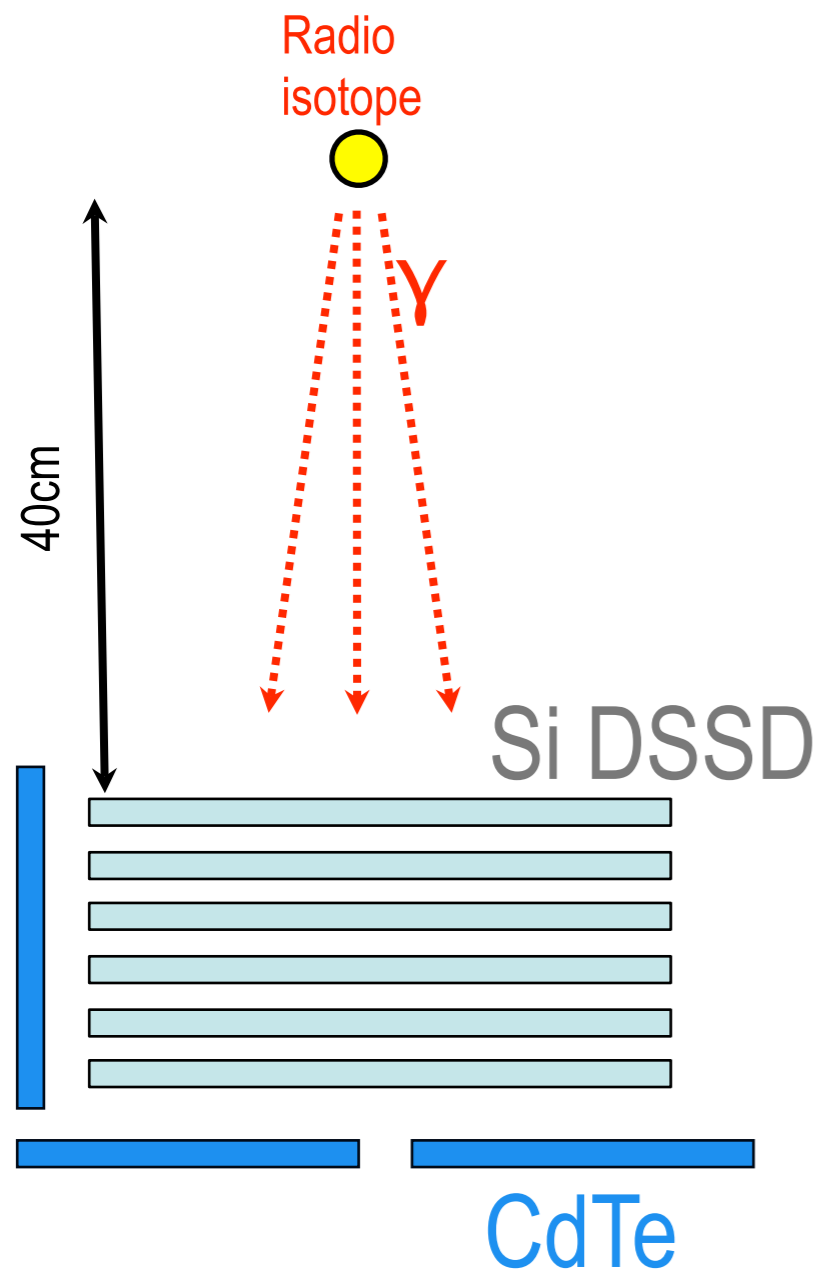

# Si/CdTe Compton Telescope

High Energy Resolution of CdTe pixel is the KEY  
for BOTH Angular Resolution and Energy Resolution

ISAS/JAXA  
w H. Tajima in  
SLAC

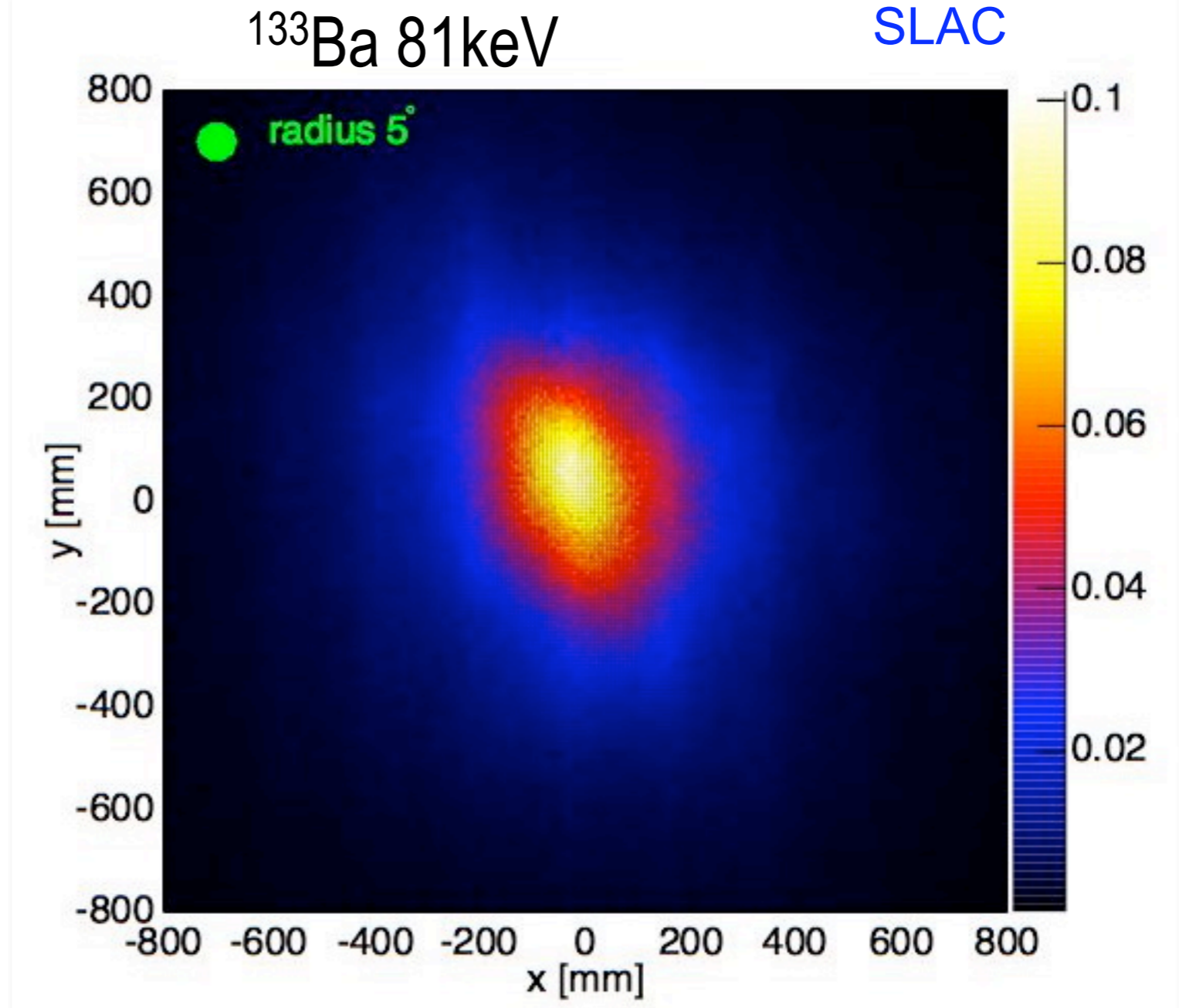
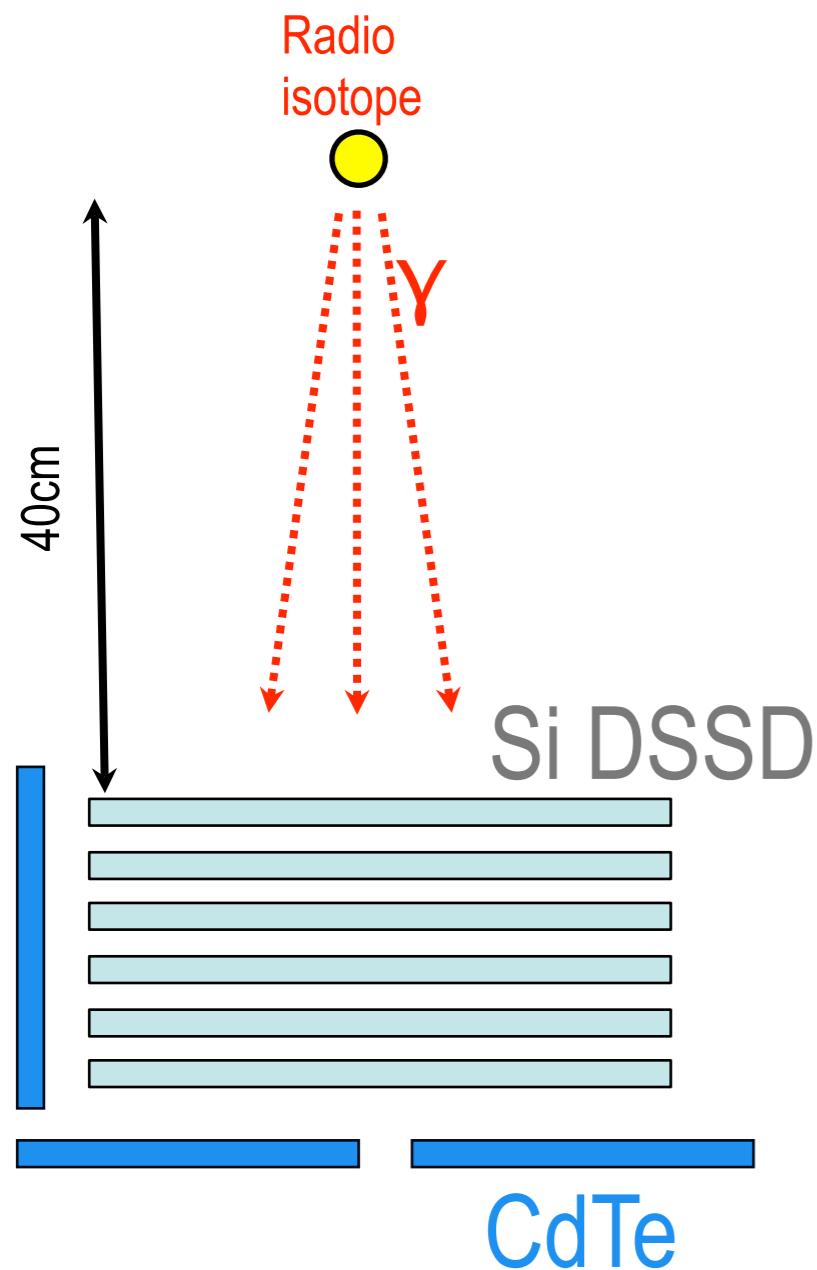



# Si/CdTe Compton Telescope

High Energy Resolution of CdTe pixel is the KEY  
for BOTH Angular Resolution and Energy Resolution

ISAS/JAXA  
w H. Tajima in  
SLAC

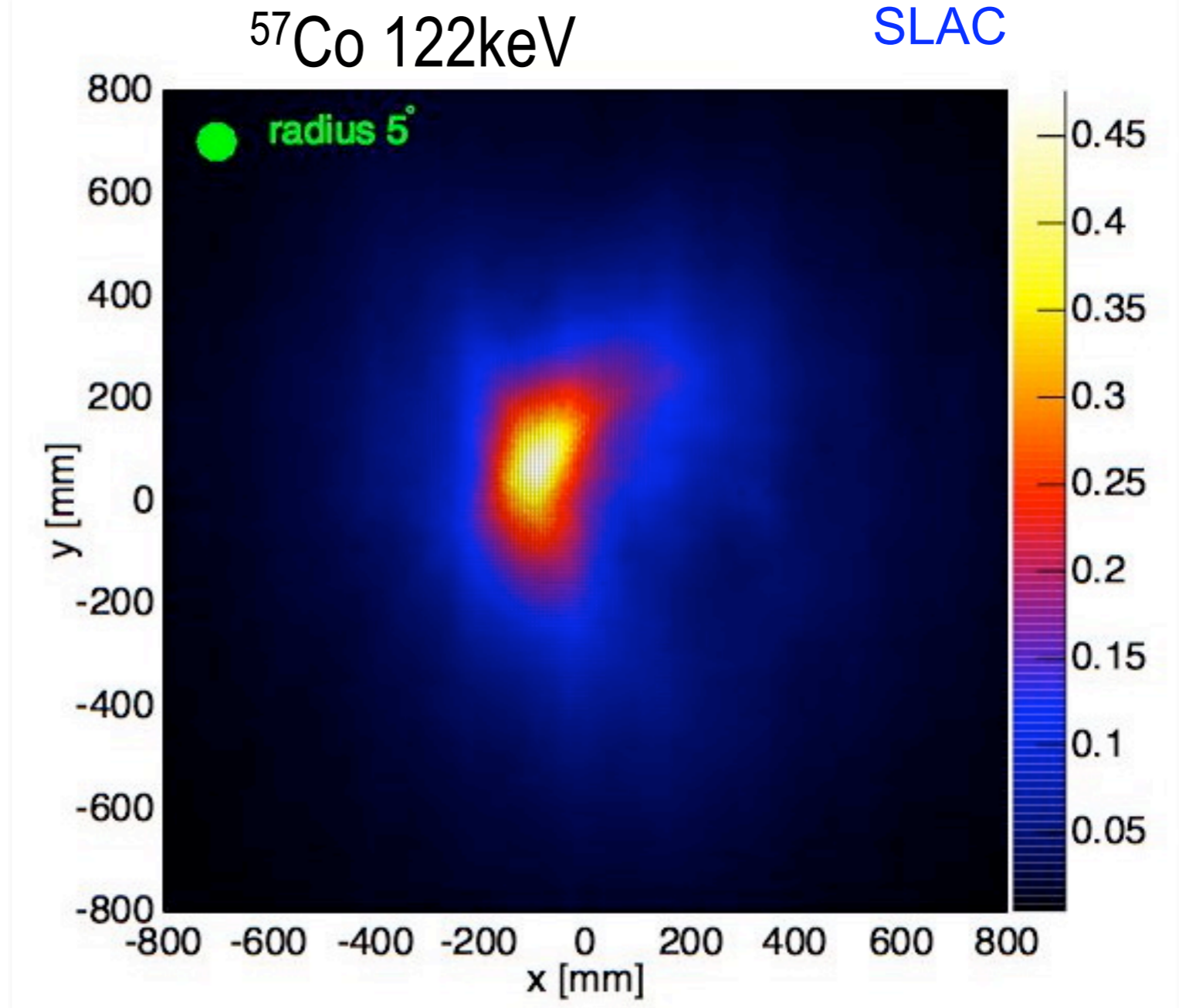
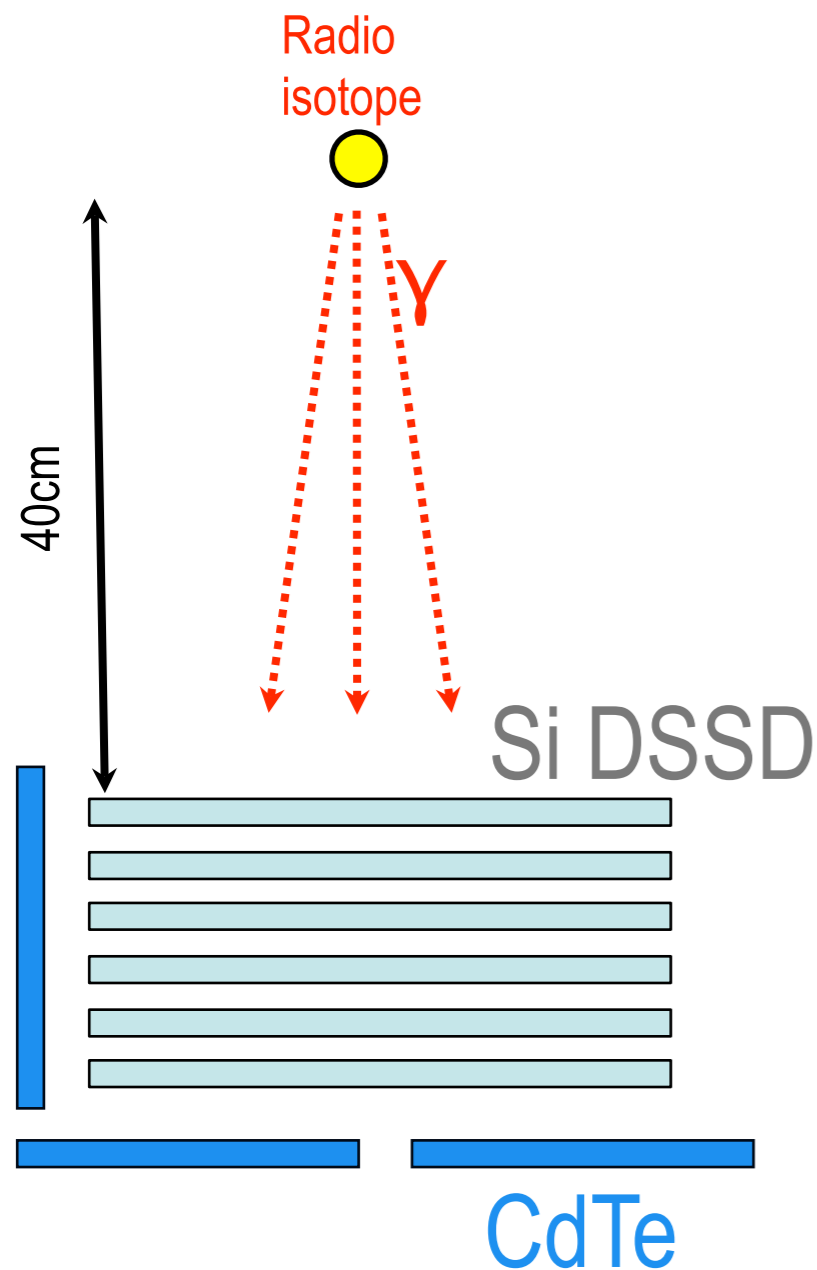

# Si/CdTe Compton Telescope

High Energy Resolution of CdTe pixel is the KEY  
for BOTH Angular Resolution and Energy Resolution

ISAS/JAXA  
w H. Tajima in  
SLAC

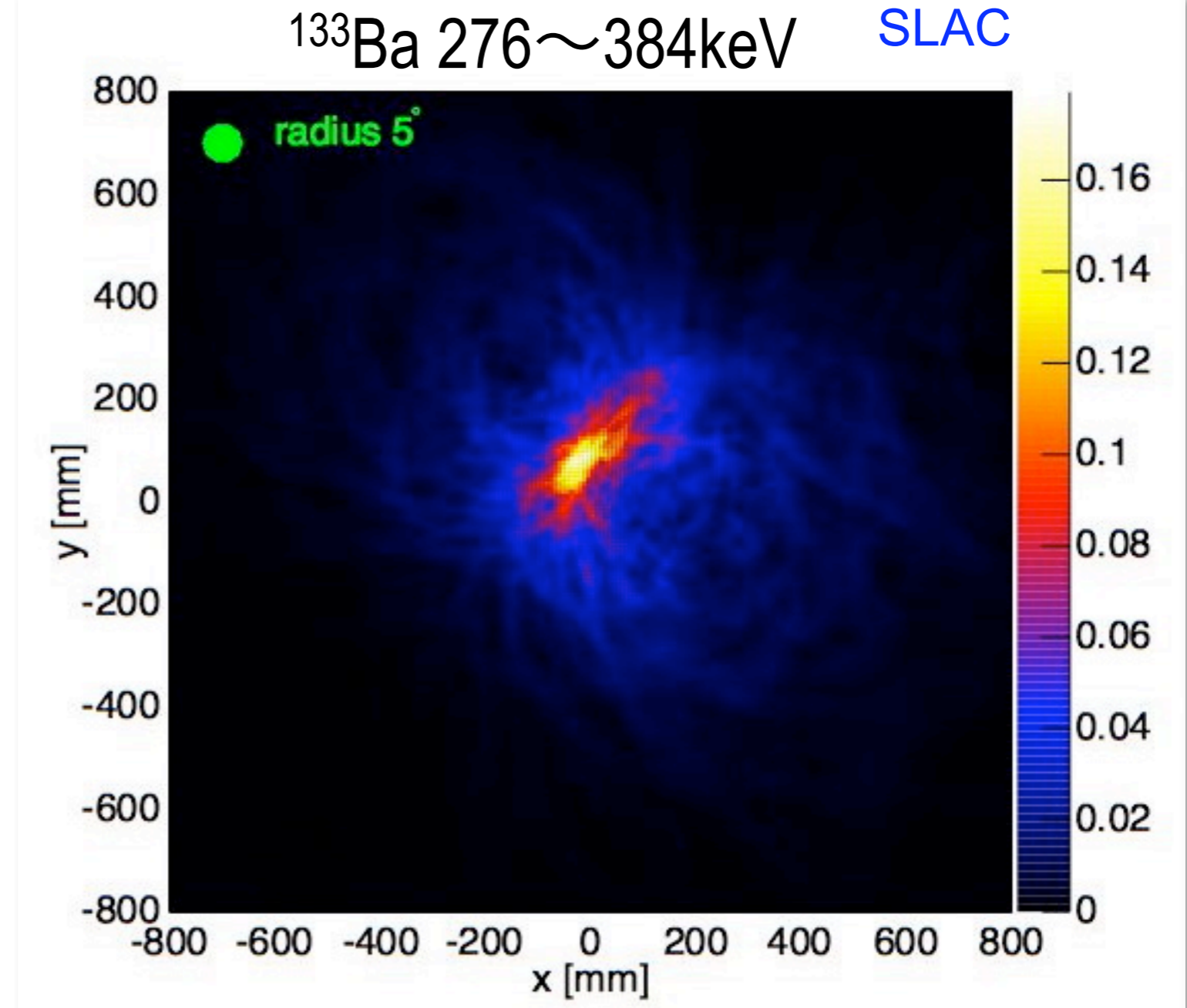
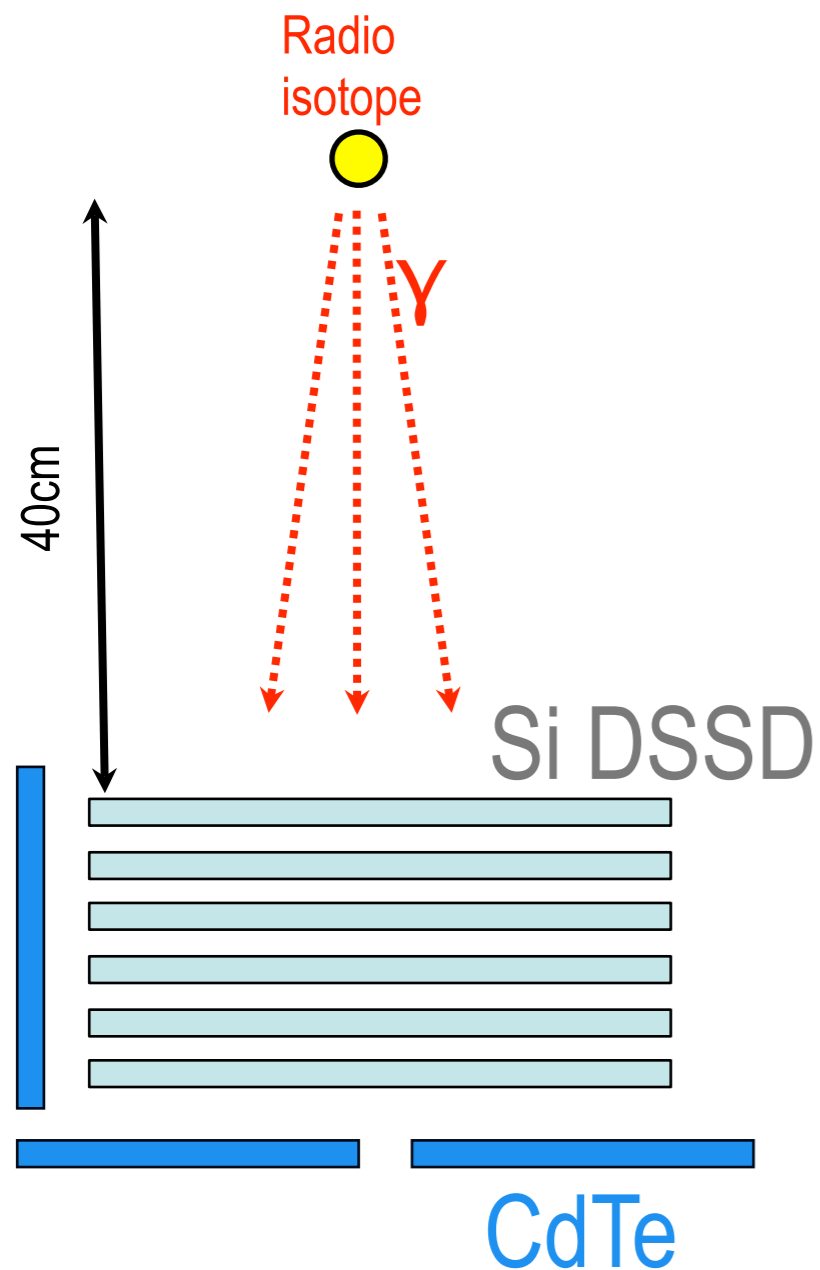



# Si/CdTe Compton Telescope

High Energy Resolution of CdTe pixel is the KEY  
for BOTH Angular Resolution and Energy Resolution

ISAS/JAXA  
w H. Tajima in  
SLAC

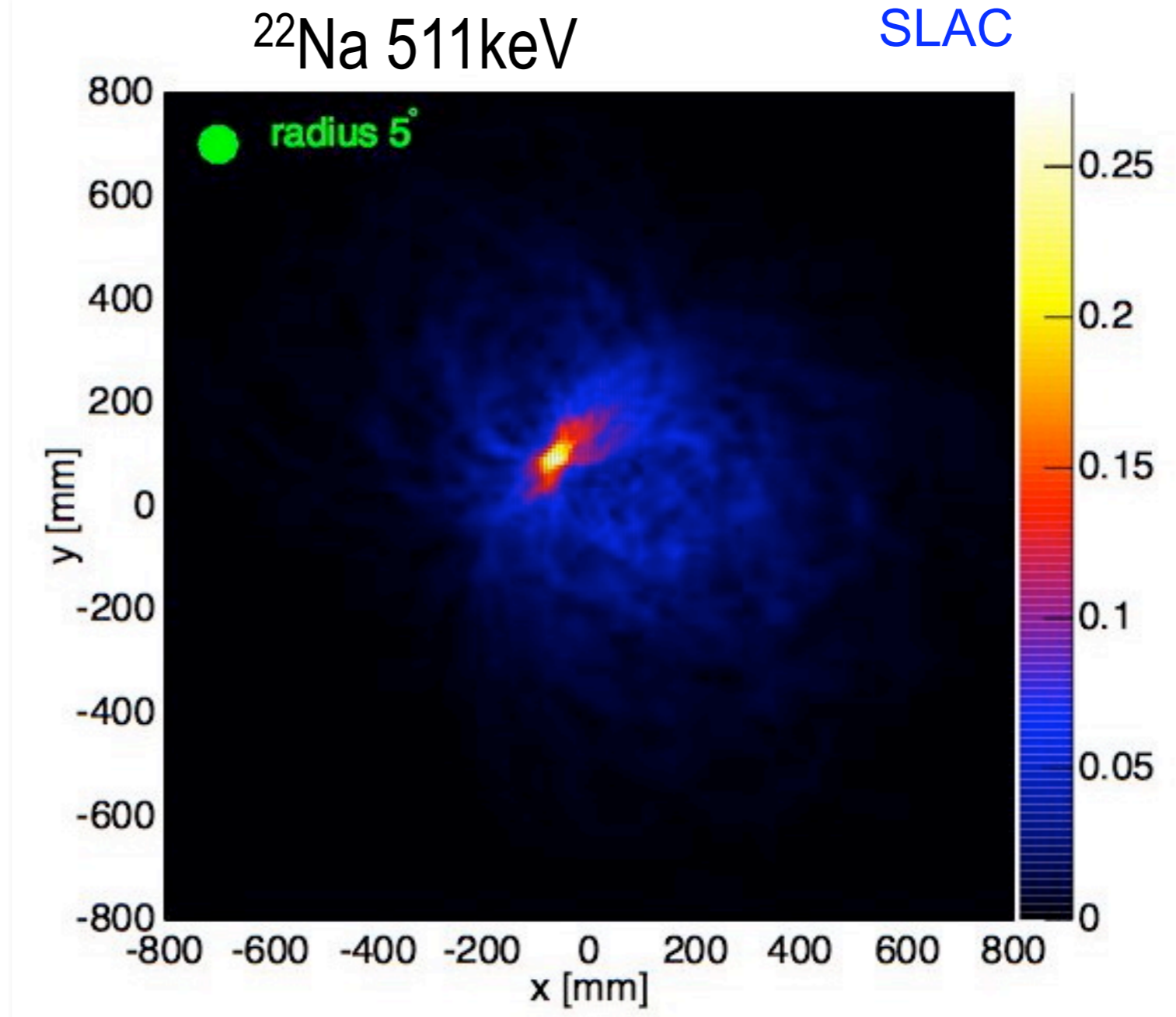
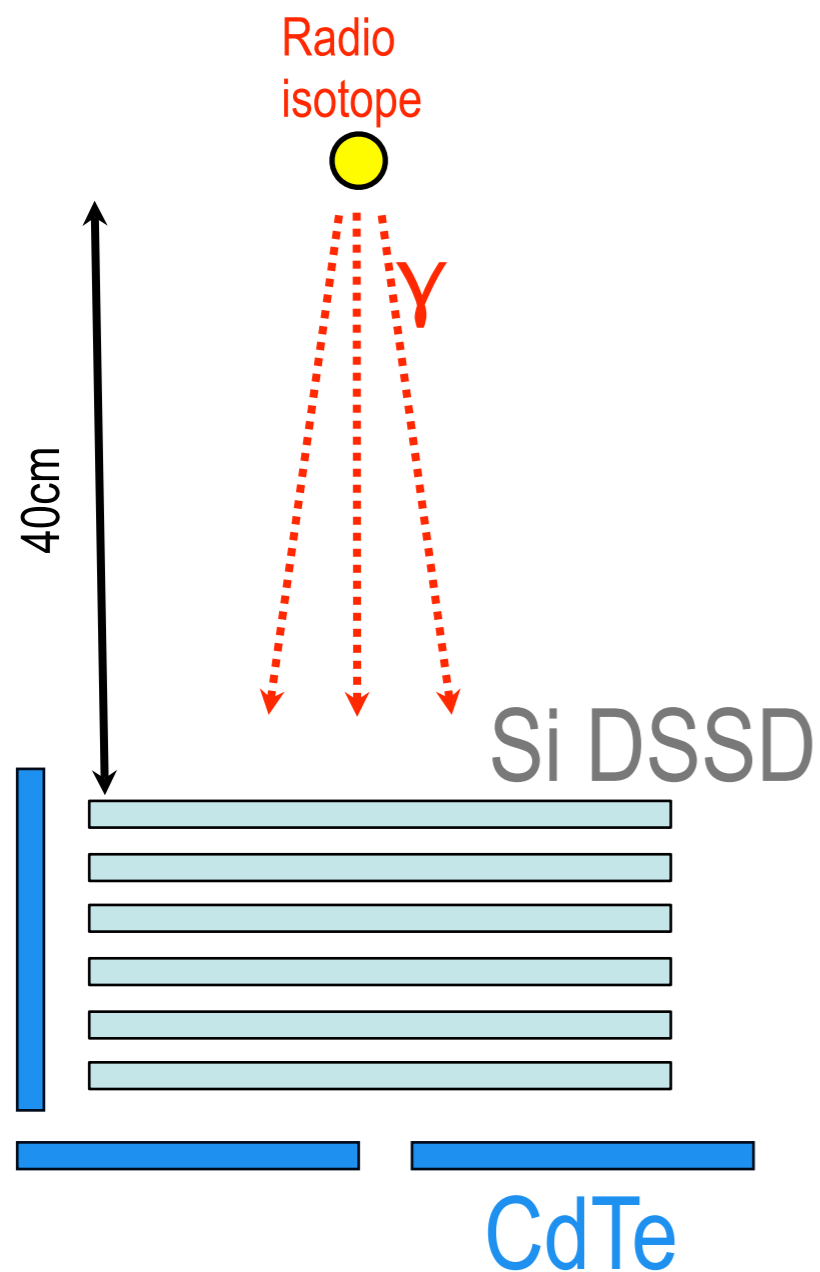

# Si/CdTe Compton Telescope

High Energy Resolution of CdTe pixel is the KEY  
for BOTH Angular Resolution and Energy Resolution

ISAS/JAXA  
w H. Tajima in  
SLAC

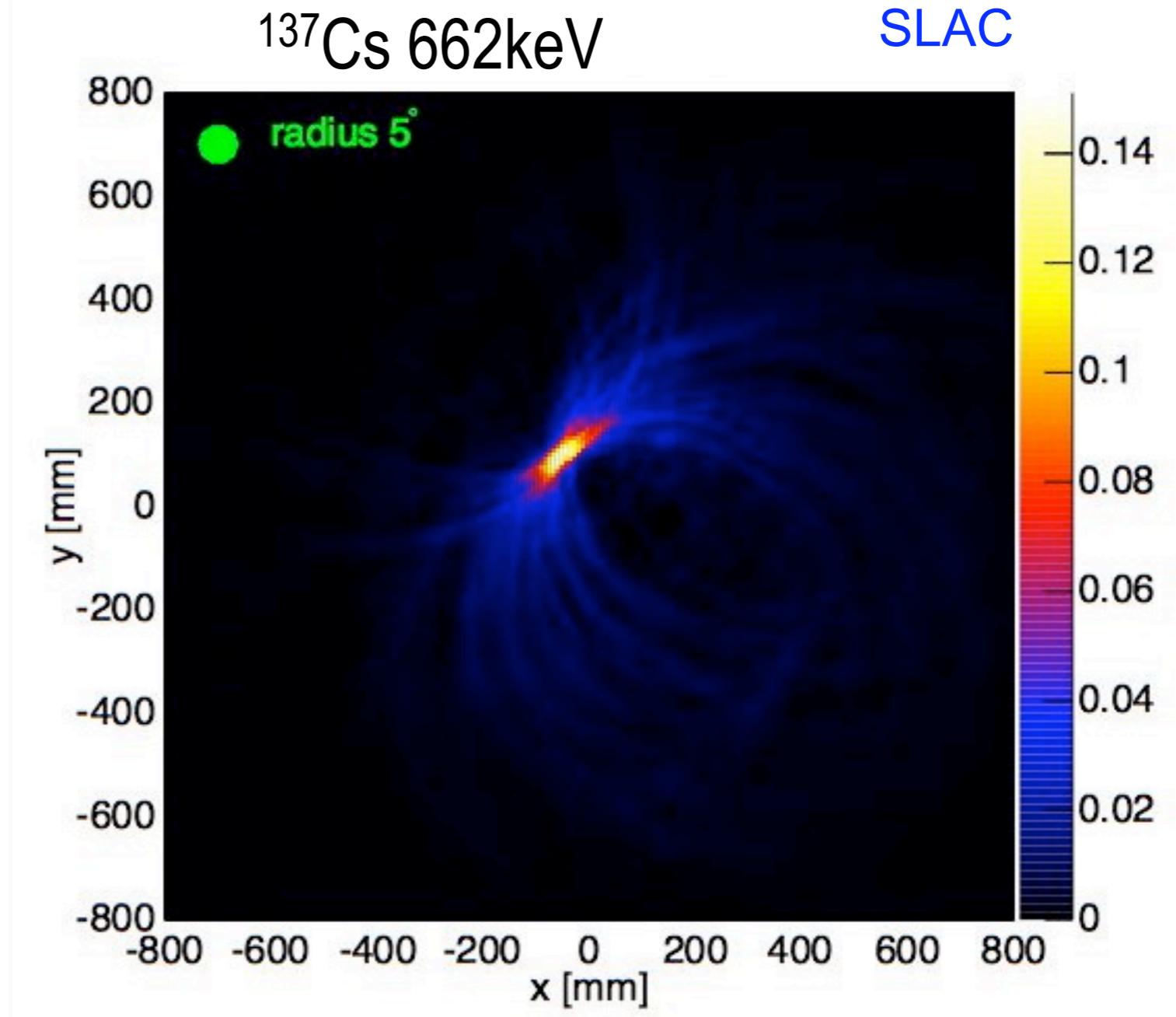
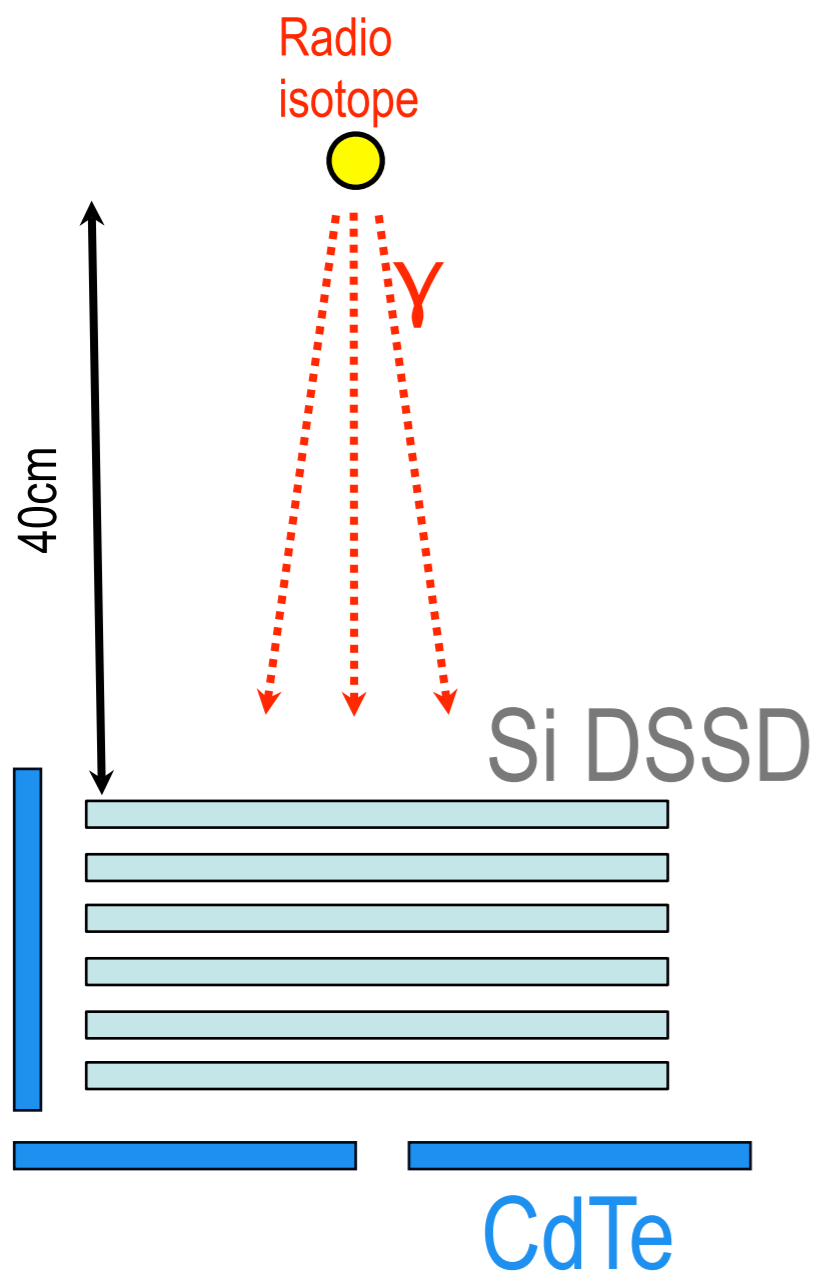



# Si/CdTe Compton Telescope

High Energy Resolution of CdTe pixel is the KEY  
for BOTH Angular Resolution and Energy Resolution

ISAS/JAXA  
w H. Tajima in  
SLAC

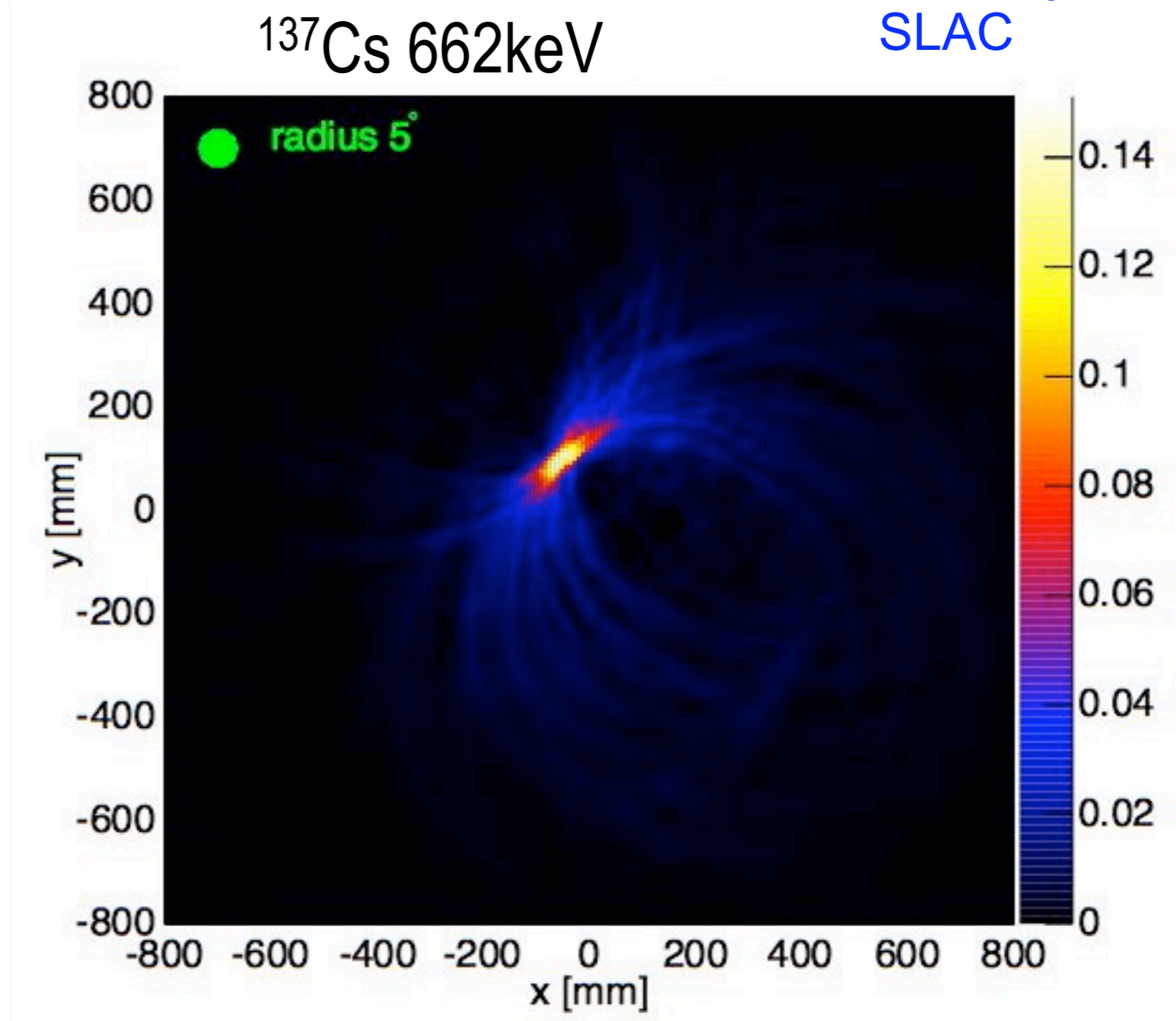
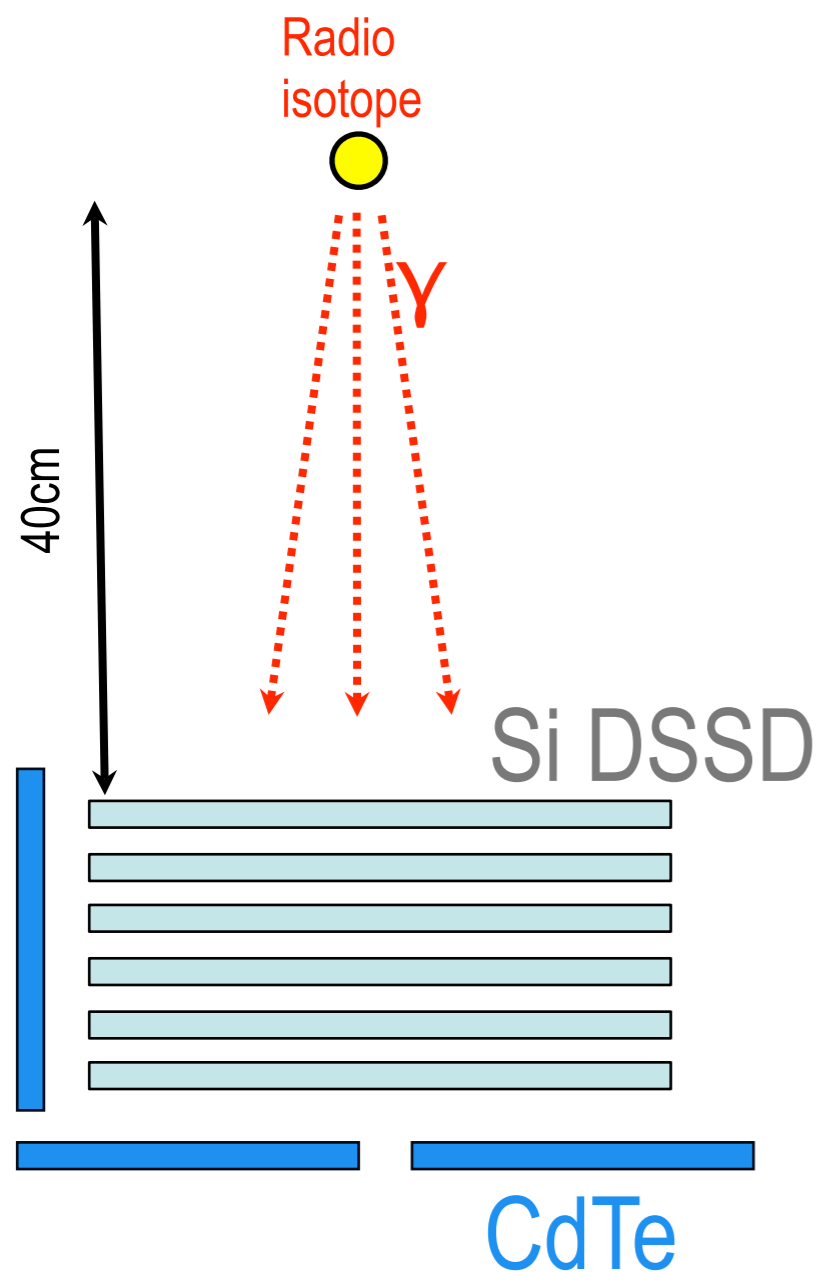

successful reconstruction in 81 — 662 keV

Watanabe et al. IEEE 2005

# Improvements

# 3D CdZnTe Detector

Z. He et al. Michigan U.

- Small Pixel Effect
- Cathode/Anode Ratio (Depth Info)
- Timing Measurement (Multiple Interaction/ Depth Info)

## Position/Energy

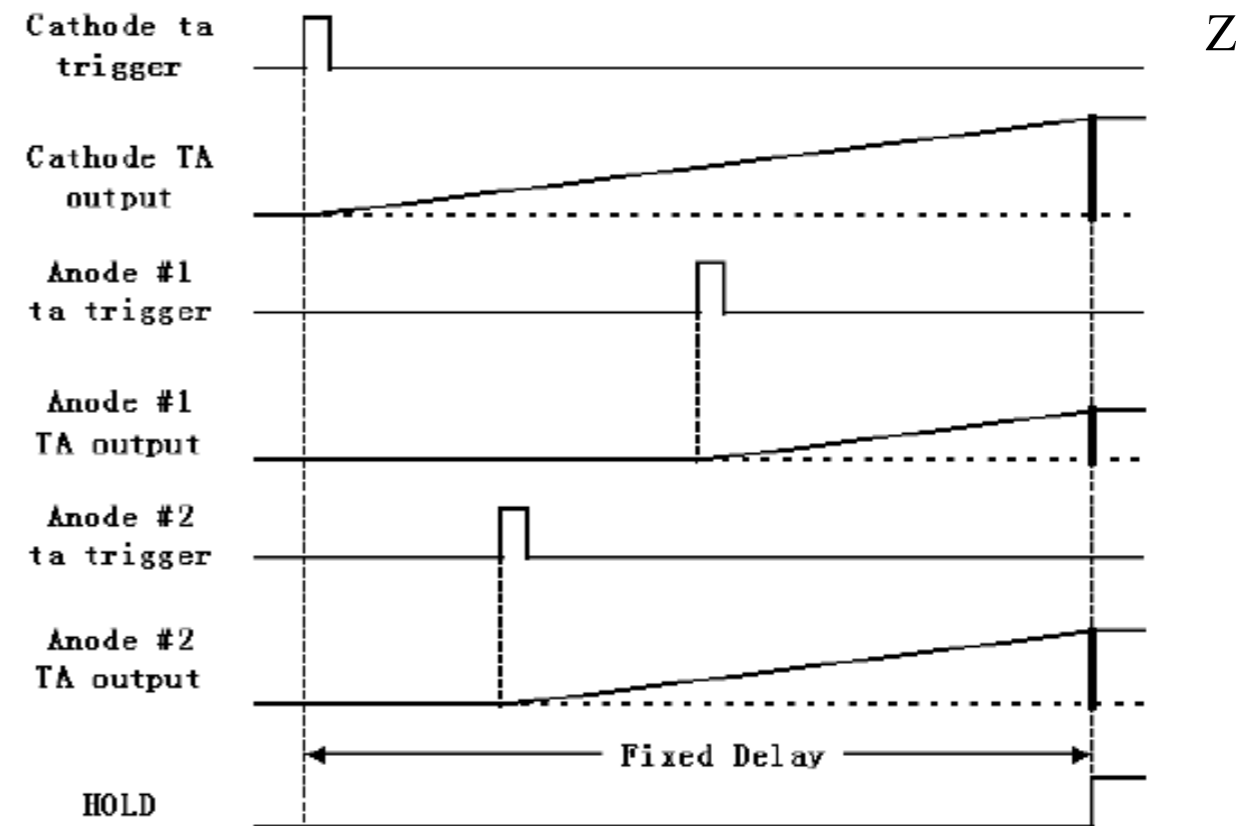
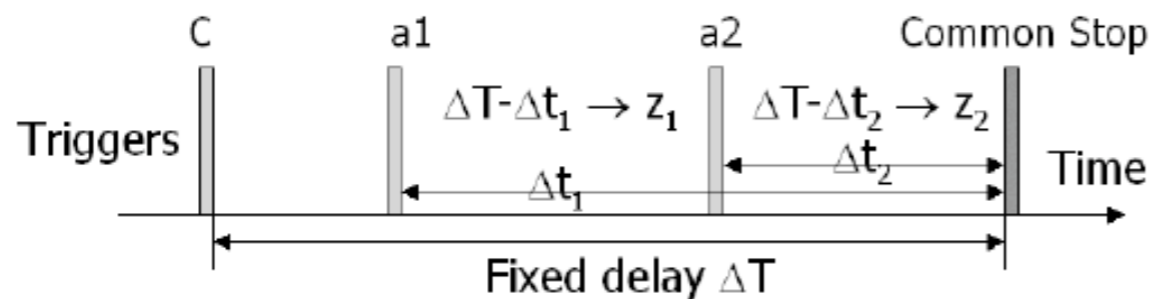
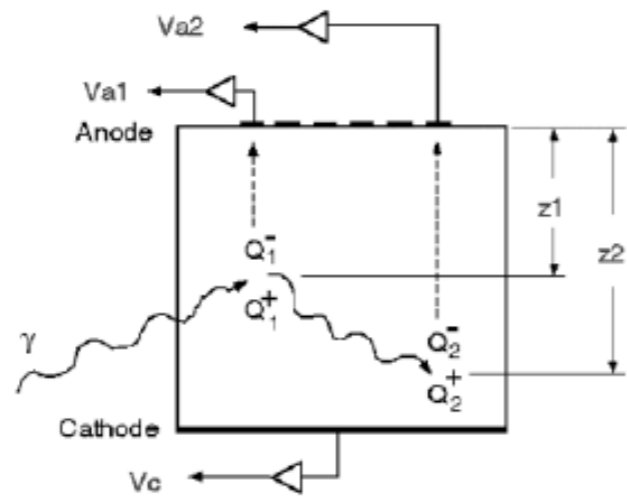
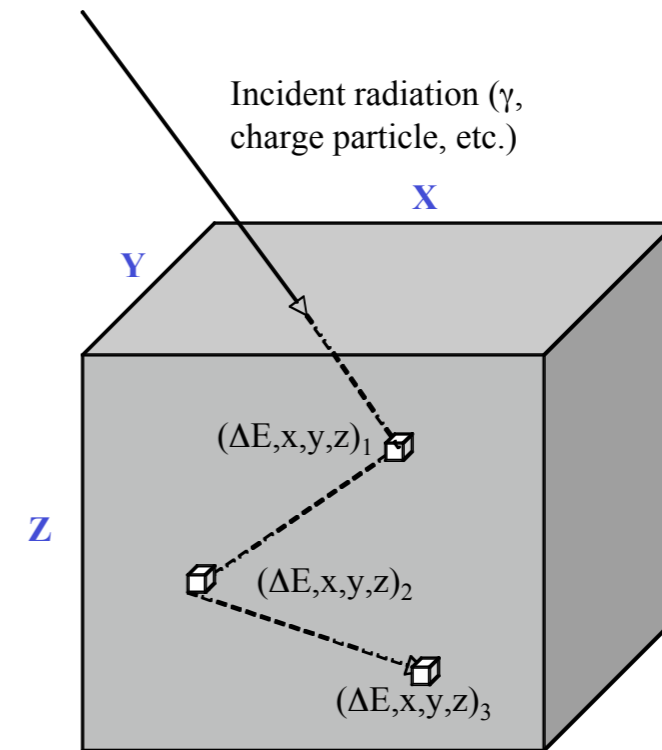



# 3D CdZnTe Detector

Spectrum of **all** 1, 2 and 3-pixel events

( Detector #2.3;  $1.5 \times 1.5 \times 1.0 \text{ cm}^3$ ;  $V_C = -1400 \text{ V}$ ;  $V_G = -45 \text{ V}$ )

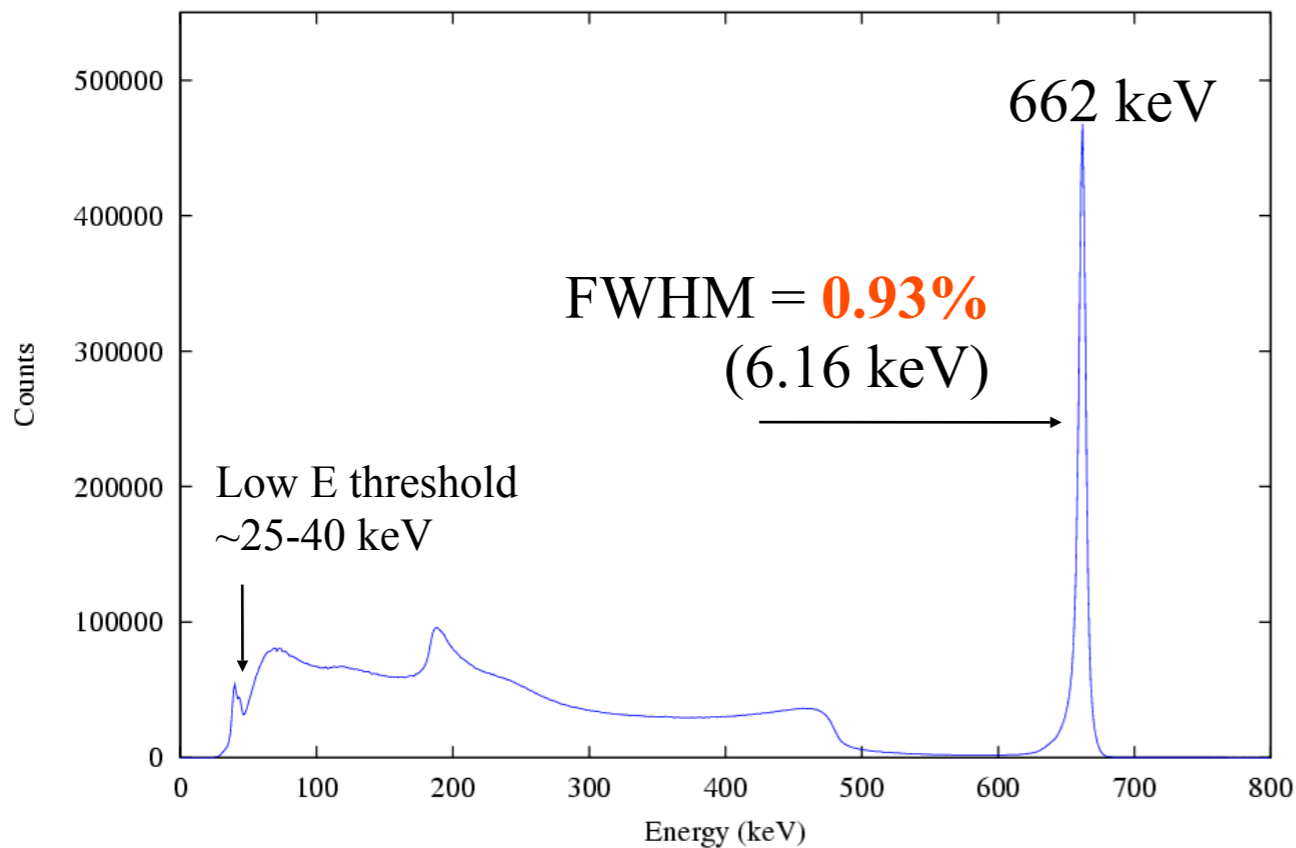

Material non-uniformity  
can be corrected by using  
Cathode/Anode  
pulse height ratio

## Compton Image Reconstruction

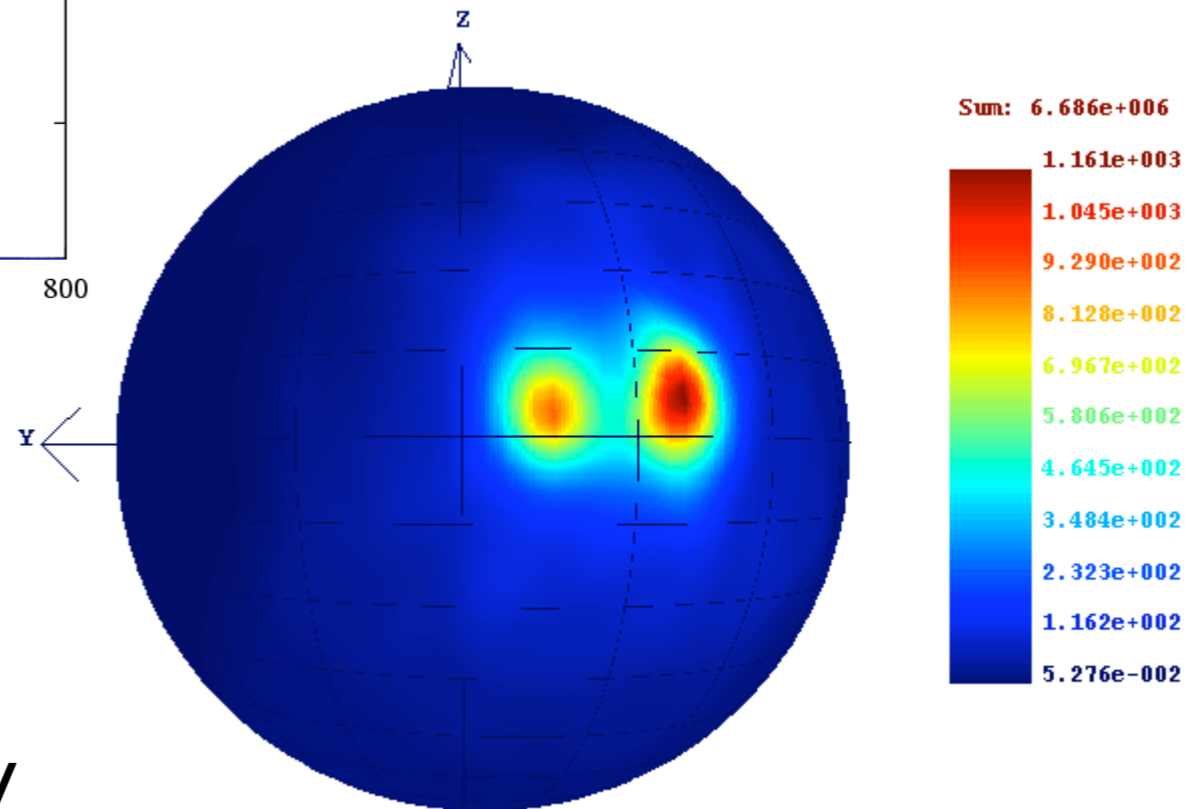

Angular resolution  
10-14 deg. for 662 keV

Angular resolution:  $14.4^\circ$  in polar angle and  $10.1^\circ$  in azimuthal direction

# CdTe/CZT pixels for future missions

**NeXT (Japan), NuStar/Con-X (US), Simbol X (Eu)**

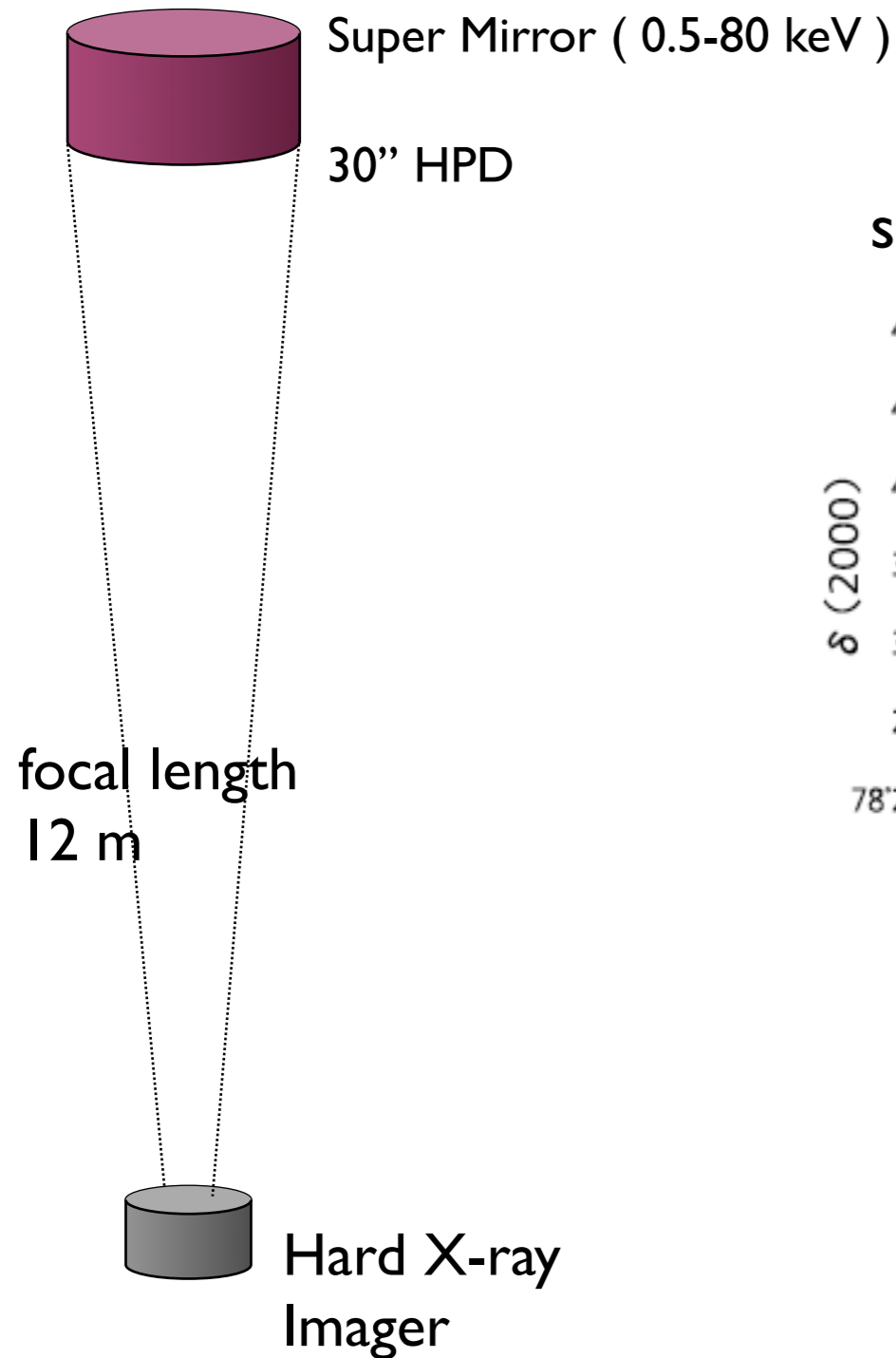

NeXT simulation : Merging Clusters

Soft X-rays  
sensitive to the heating

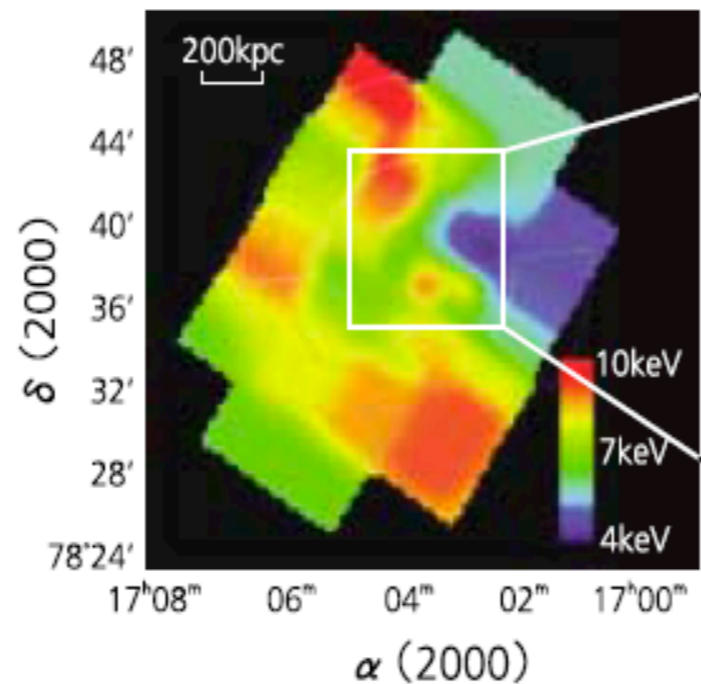

Hard X-rays ( $E > 10$  keV)  
sensitive to non-thermal emission

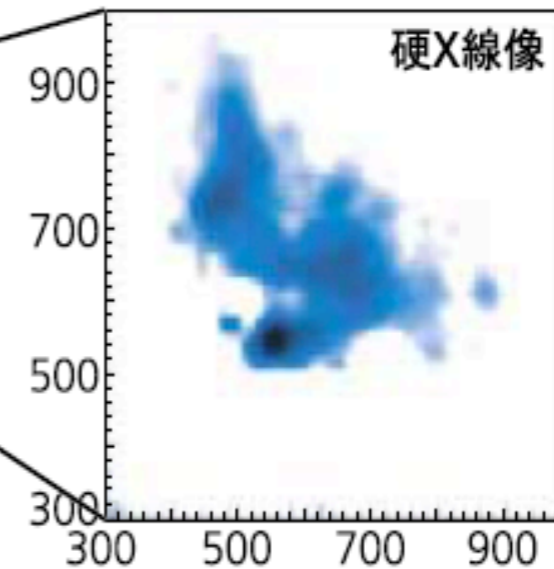

NuStar simulation : Galactic Center Region

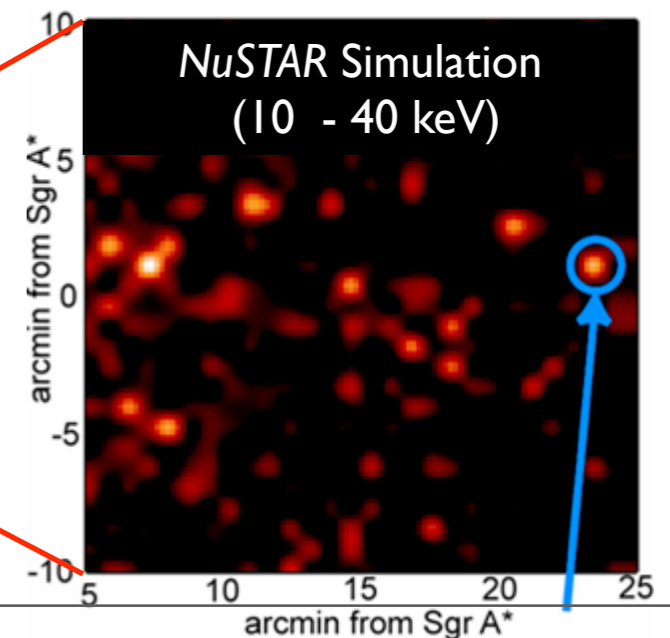
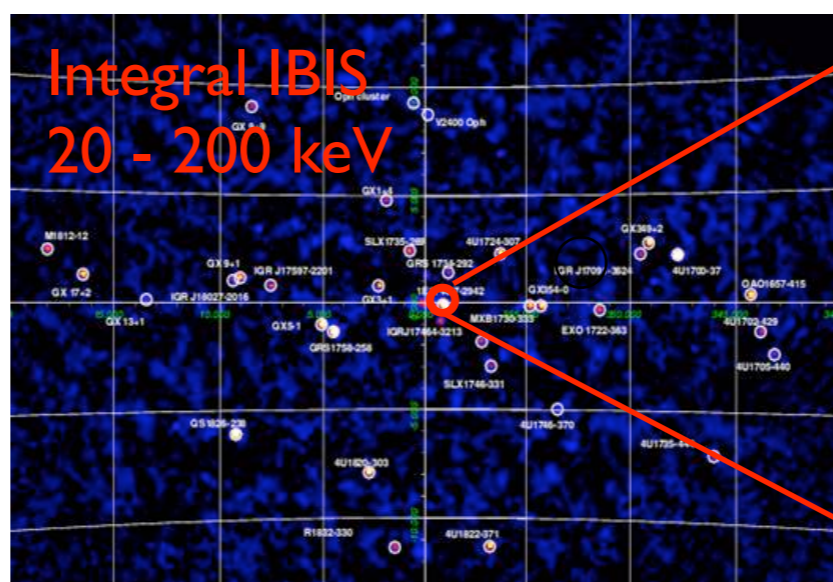

# Key tech. for pixels and array

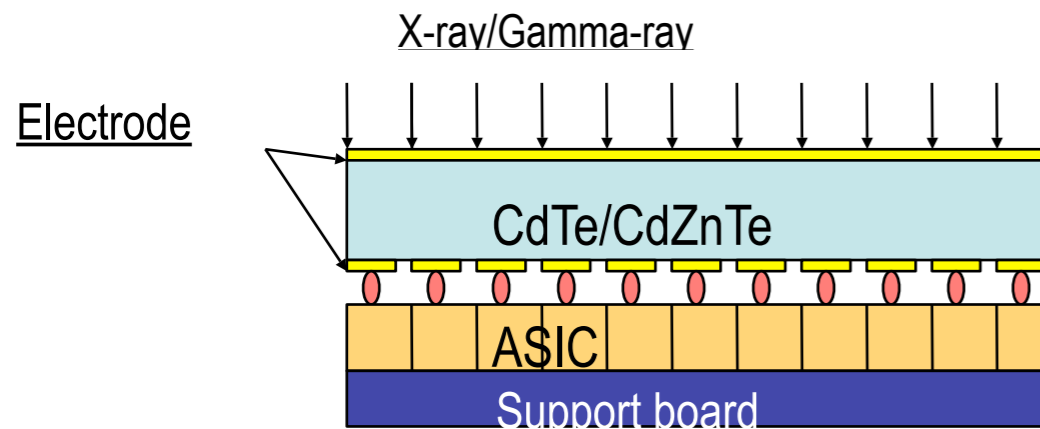

ASICs

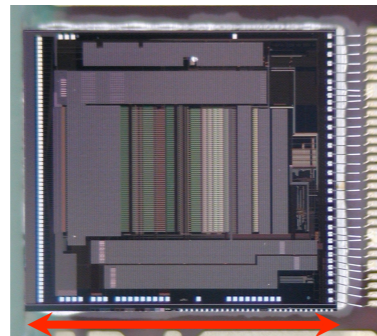
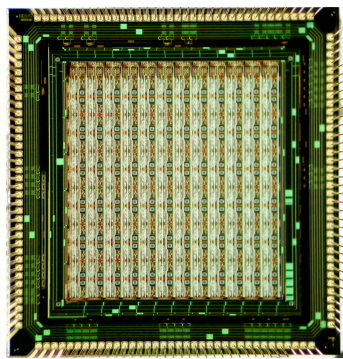

7 mm

**Relatively Large Capacitance**  
 (1 pF - 10 pF)  
**Self Trigger Capability (discr/pixel)**  
 Goal : ENC ~50 e<sup>-</sup> RMS at 0 pF  
 ( ΔE < 1 keV at 60 keV)  
 100-200 microW/pixel

## Bump Bonding

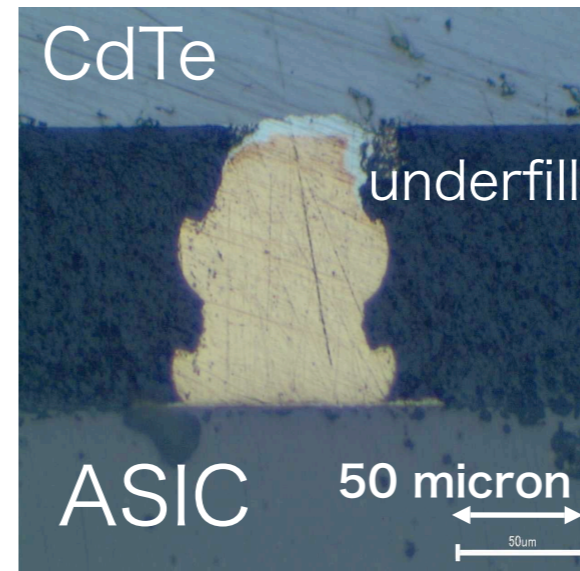

Example:  
In/Au Stud

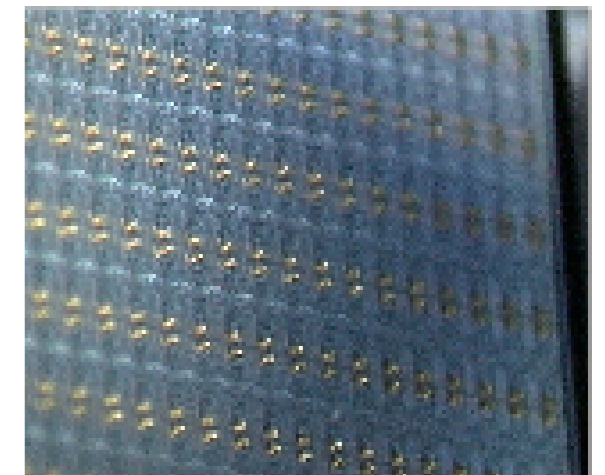

US 6,992, 292 B2  
 (Kuroda and Takahashi)

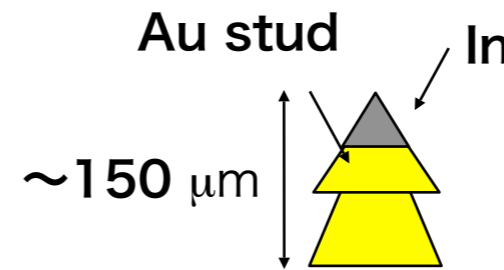

Similar to the efforts for Si pixels  
 but CdTe/CZT need special care  
 for the process  
 Stress/Temperature



# Toward Fine Pitch CdTe/CdZnTe pixels with spectroscopic capabilities (1)

F.A. Harrison et al. (Caltech)

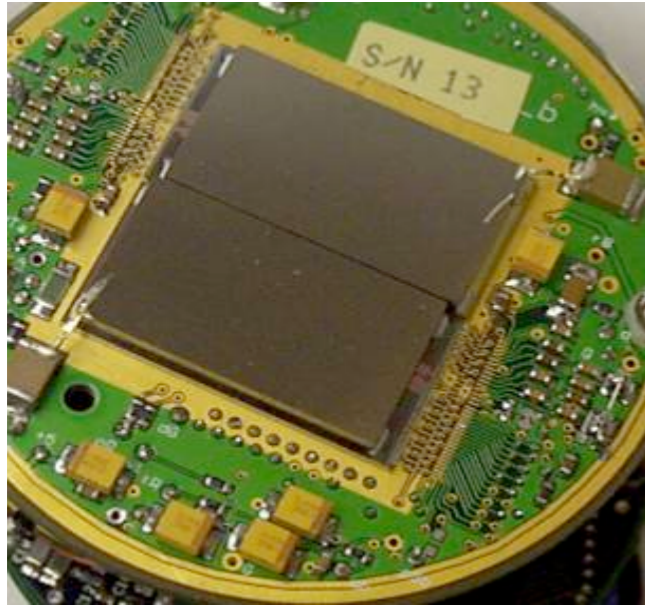

Two hybrid CdZnTe/ASIC side by side

500 micron pixels  
1056 ch

Spectrum taken with CdZnTe

Caltech

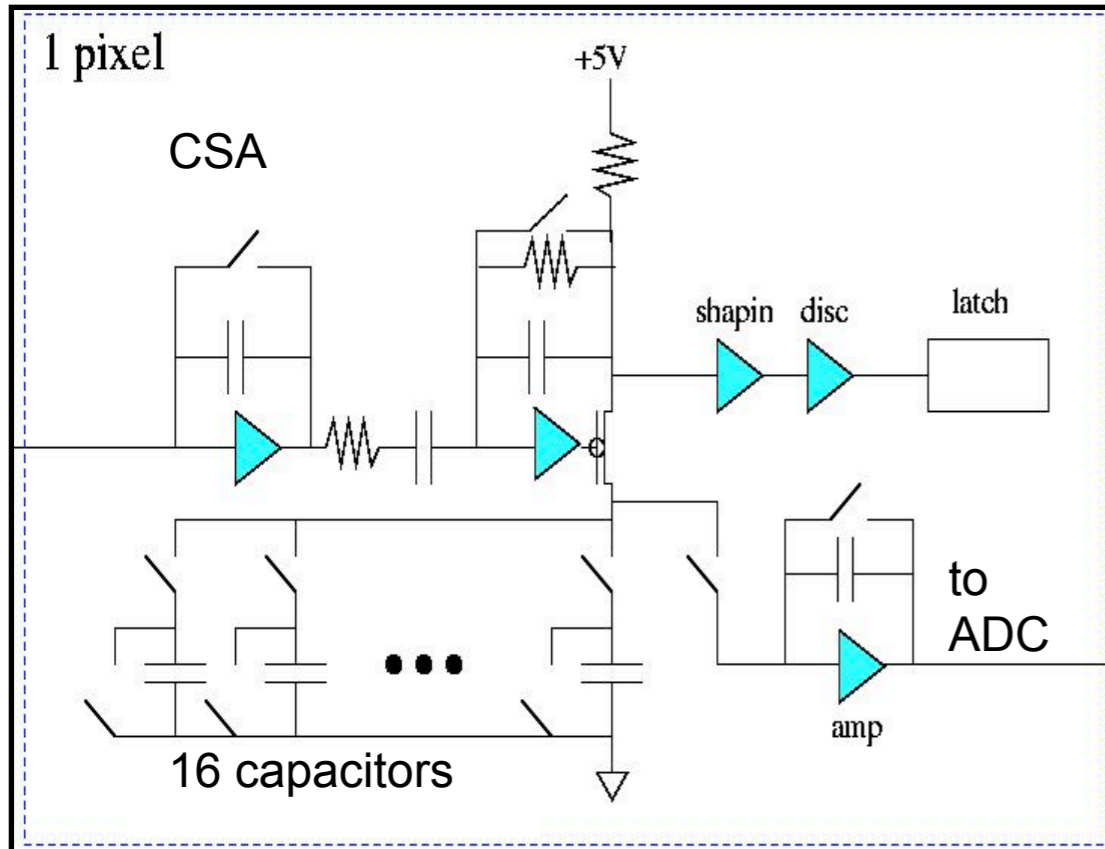
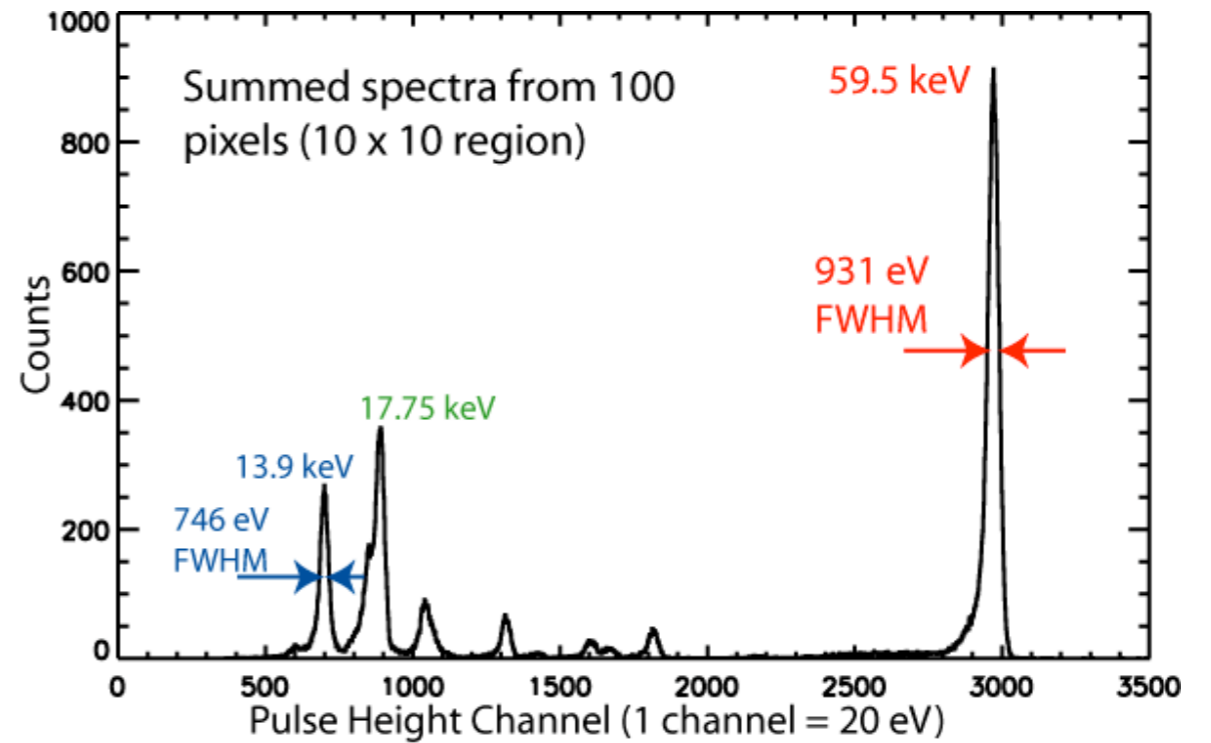

F. A. Harrison, et al. SPIE 2003

Image taken with CdTe (shows better uniformity)

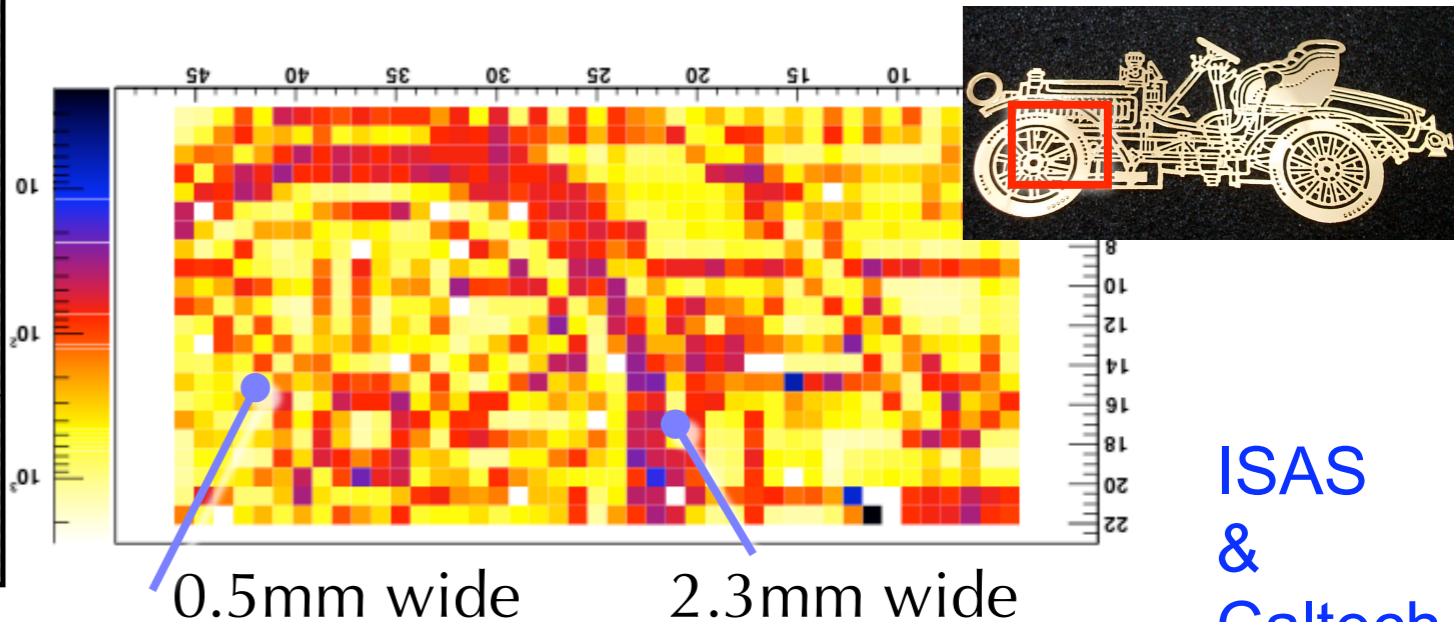

# Toward Fine Pitch CdTe/CdZnTe pixels with spectroscopic capabilities (2)

H. Ikeda et al. (ISAS/JAXA)

64 x 64 pixel analog VLSI "H02"

Process : TSMC 0.25 $\mu$ m CMOS  
Pixel size : 200  $\mu$ m

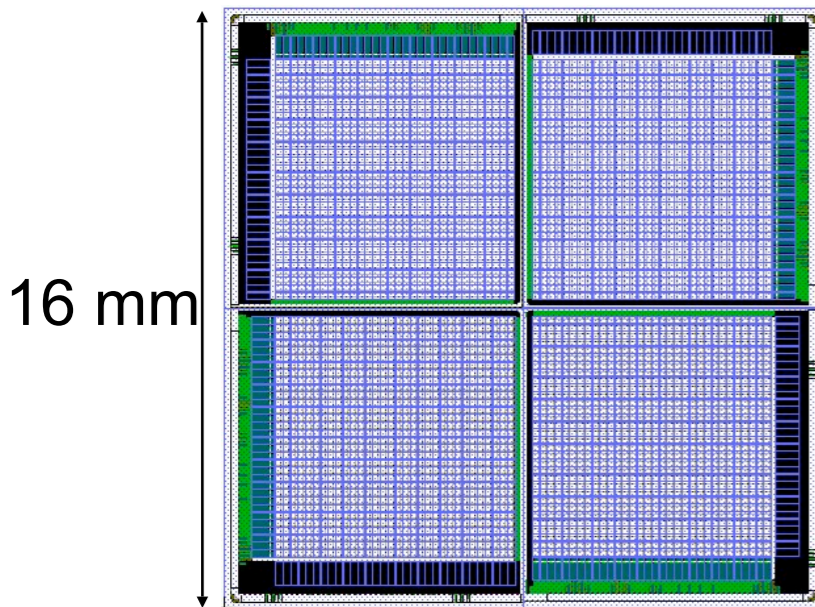

Schematic diagram

Bump Pad  
60  $\mu$ m

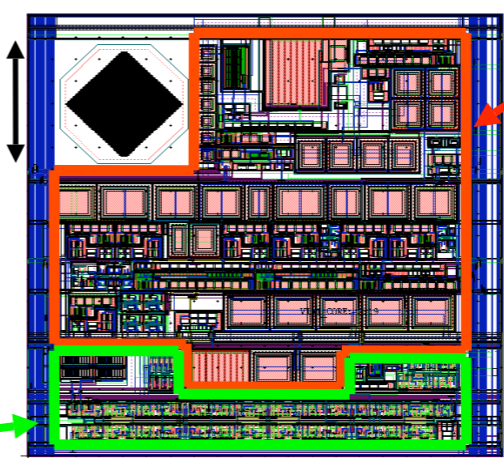

Analog circuit

200 $\mu$ m

Digital circuit

a pixel layout

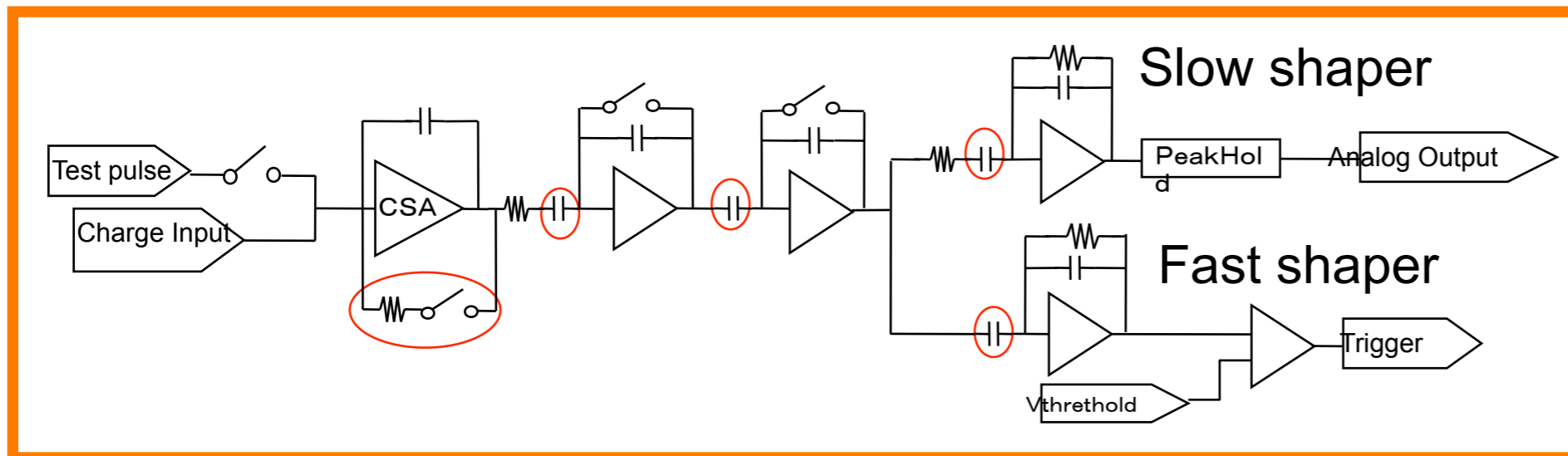

To make an ASIC with this complex circuit is not an easy task.

SPICE tells  
Noise (RMS)  
55 + 34 e- / pF

# Summary



- CdTe/CdZnTe : attractive material for gamma-ray imaging  
Now widely available in the market  
(after 10 years of efforts in industries)  
Big Market in Space (INTEGRAL/Swift/NeXT/Symbol-X/Con-X...)
- Possible solution for **Charge Trapping** : Thin CdTe diode and Single Polarity Charge Sensing
- Requirements range from “**m<sup>2</sup> large array**” with mm resolution to “**cm<sup>2</sup> pixel detector**” with several 10 micron resolution.
- Photo-counting chip with the pixel size of 50 micron x 50 micron already exists (Medipix2). Efforts to make **ASICs for spectroscopy** are on-going for CdTe/CdZnTe pixels.
- **Photo-response uniformity** becomes very important issue, when we plan to make array detectors with many elements
- Strong demands for lower prices of wafers  
→ mass production

ex. EXITE Mission (US)  
**5.64 m<sup>2</sup> CdZnTe**

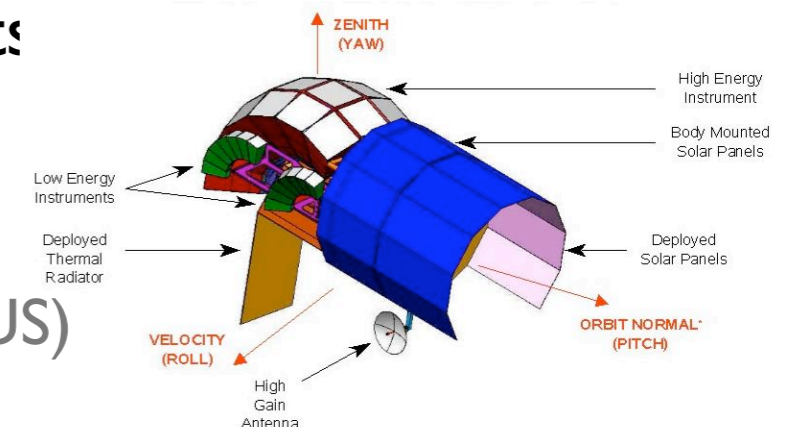



# Angular Resolution

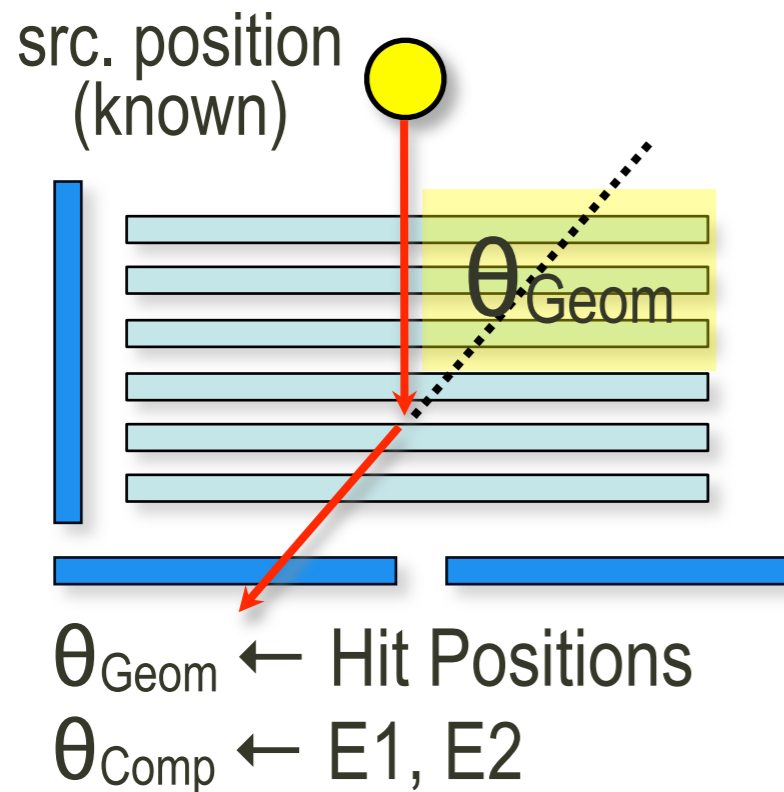

$\theta_{\text{Comp}} - \theta_{\text{Geom}}$

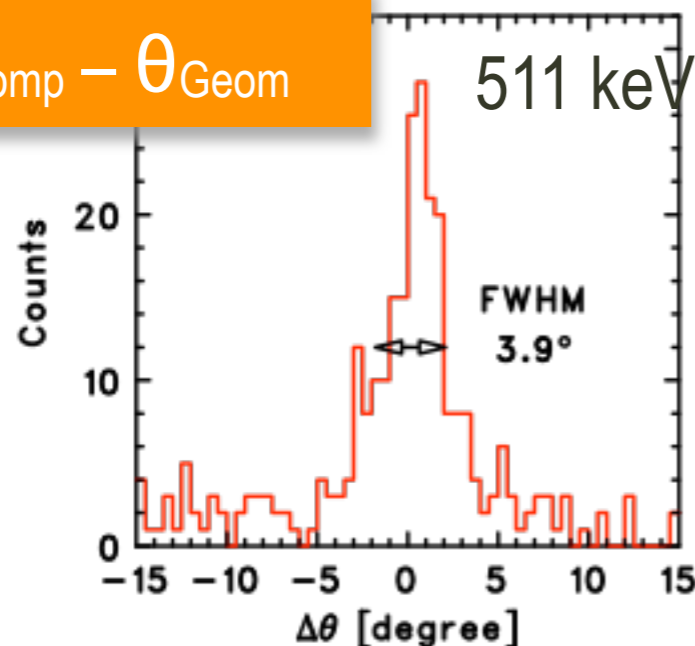

## Si/CdTe Compton

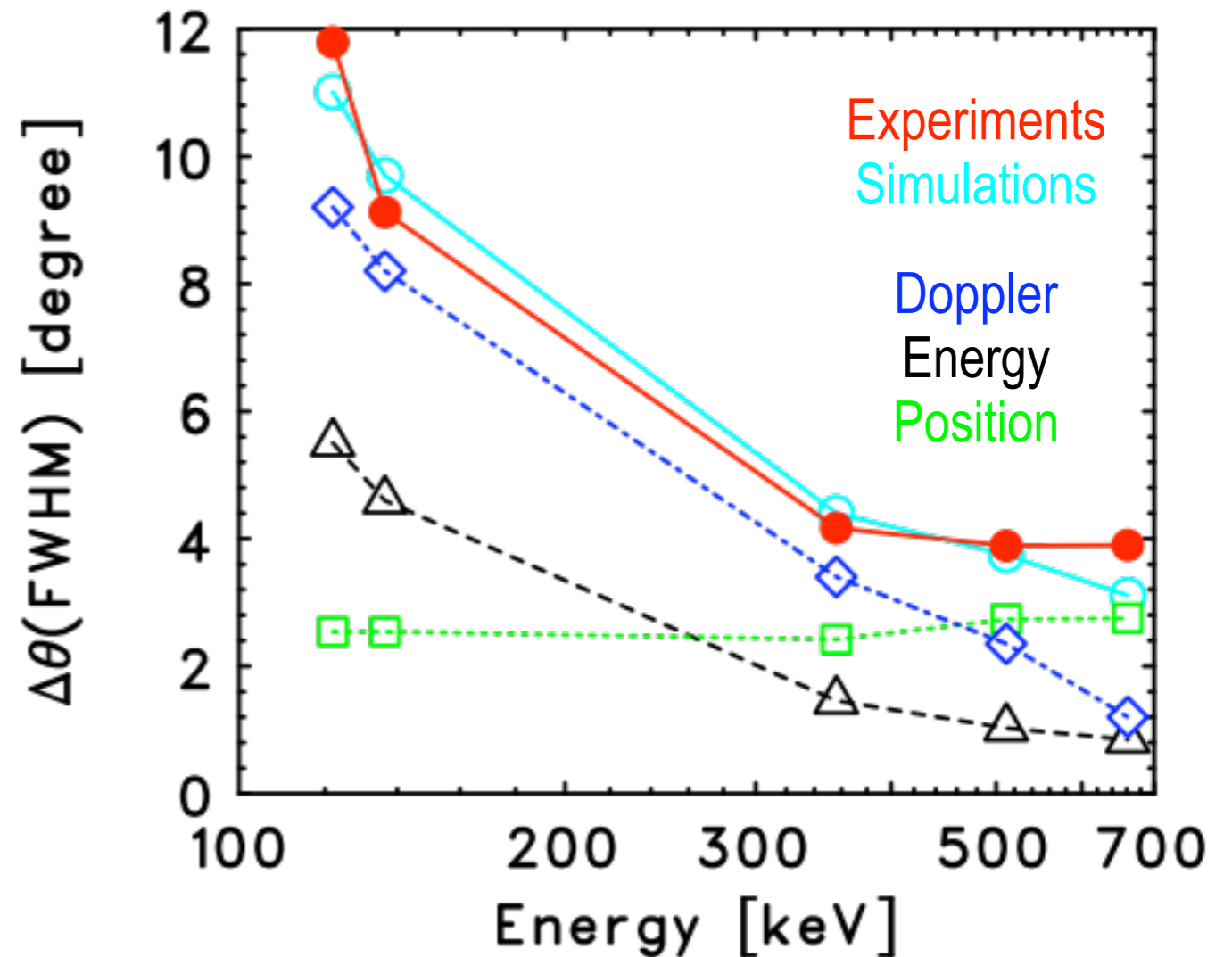

## CdTe-only Compton

12 degree at 511 keV  
(Doppler Limited)

# Stacked Detector for $E > 1 \text{ MeV}$

## Stacked CdTe

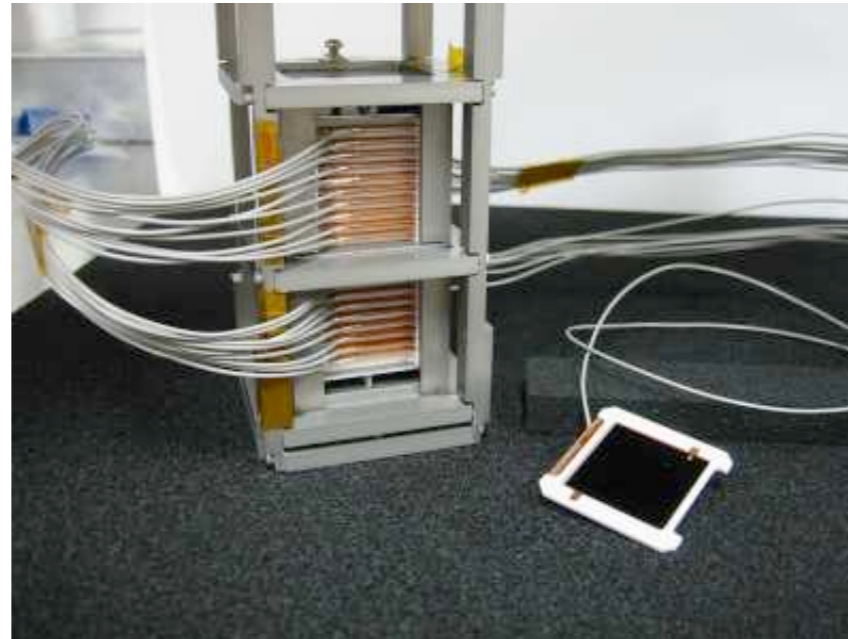
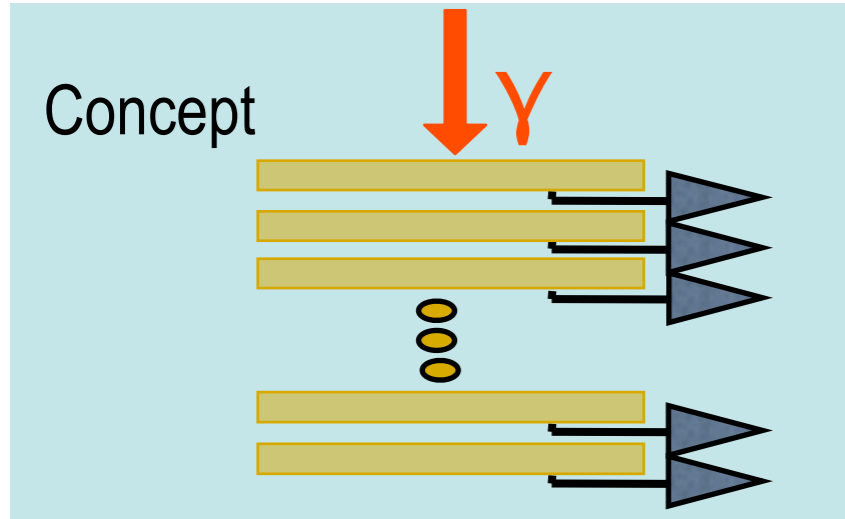

2cm x 2cm:  
Planar (no pixel)  
40 layer = 20 mm

### Approach:

- Stack of thin CdTe detectors
1. to get high efficiency for high energy photons.
  2. still keeping high energy resolution at low energy

Only possible,  
if the detector is **fully active**.

